

GH series

INSTRUCTION MANUAL

Analytical Balance

GH-120

GH-200

GH-300

GH-202



GH-252

AND

A&D Company, Limited

This manual and Marks

All safety messages are identified by the following, "WARNING" or "CAUTION", of ANSI Z535.4 (American National Standard Institute: Product Safety Signs and Labels). The meanings are as follows:

 WARNING	A potentially hazardous situation which, if not avoided, could result in death or serious injury.
 CAUTION	A potentially hazardous situation which, if not avoided, may result in minor or moderate injury.



This is a hazard alert mark.



This mark is the IEC417 mark for "Caution. Hot surface".
Do not touch parts affixed with this mark without adequate protection.



This mark informs you about the operation of the product.

- This manual is subject to change without notice at any time to improve the product.
- Product specifications are subject to change without any obligation on the part of the manufacturer.
- Under the copyright laws, the instruction manual and the software (program) described in it are copyrighted, with all rights reserved.
The software may be installed into one computer and may not be installed into other computers without the prior written consent of A&D Company. Copying includes translation into another language, reproduction, conversion, photocopy and offer or loan to another person.
- The purchaser may make one copy of the software for backup purposes.
The manual and the software may not be copied, in whole or part, except as described above.
- Windows, Word and Excel are registered trademarks of the Microsoft Corporation.

Contents

Basic Operation

1.	Introduction	3
1.1.	About This Manual	3
1.2.	Features	3
1.3.	Compliance	4
2.	Unpacking the Balance	5
2.1.	Installing The Balance	6
3.	Precautions	6
3.1.	Before Use	6
3.2.	During Use	7
3.3.	After Use	8
3.4.	Power Supply	8
4.	Display Symbols and Key Operation	9
5.	Weighing Units	10
5.1.	Units	10
5.2.	Changing the Units	11
6.	Weighing	12
6.1.	Basic Operation (Gram Mode)	12
6.2.	Dual Range	13
6.3.	Counting Mode (PCS)	14
6.4.	Percent Mode (%)	16

Adapting To The Environment

7.	Response Adjustment	17
7.1.	Automatic Response Adjustment	17
7.2.	Manual Response Adjustment	18
8.	Calibration	19
8.1.	Calibration Group	19
8.2.	Automatic Self Calibration	20
8.3.	One-Touch Calibration	20
8.4.	Calibration Test Using The Internal Mass	21
8.5.	Calibration Using An External Weight	22
8.6.	Calibration Test Using An External Weight	23
8.7.	Correcting The Internal Mass Value	24

Selecting Functions

9.	Function Switch And Initialization	25
9.1.	Permit Or Inhibit	25
9.2.	Initializing The Balance	26
10.	Function Table	27
10.1.	Details Of The Function Table	28
10.2.	Display Symbol And Keys	30
10.3.	Description Of The Class "Environment, Display"	31
10.4.	Description Of The Item "Data Output Mode"	32
10.5.	Description Of The Item "Data Format"	33
10.6.	Data Format Examples	36

10.7.	Clock And Calendar Function	38
11.	ID Number And GLP Report.....	40
11.1.	Setting The ID Number	40
11.2.	GLP Report	41
12.	Data Memory	46
12.1.	Notes on Using Data Memory	46
12.2.	Data Memory for Weighing Data	47
12.3.	Data Memory for Calibration and Calibration Test	50
13.	Underhook	51
14.	Density Measurement.....	52
Interface And Communication		
15.	Standard Input & Output Interface	55
15.1.	RS-232C Interface.....	55
15.2.	Connection to peripheral equipment	56
15.3.	Commands	58
Maintenance		
16.	Maintenance	62
16.1.	Treatment Of The Balance	62
16.2.	Error Codes	62
16.3.	Other Display	64
16.4.	Checking The Balance Performance And Environment	65
16.5.	Asking For Repair.....	65
17.	Specifications.....	66
17.1.	External Dimensions	67
17.2.	Options and Peripheral Instruments.....	68
18.	Terms/Index	70
18.1.	Terms.....	70
18.2.	Index.....	71

1. Introduction

This manual describes how the balances of GH series work and how to get the most out of them in terms of performance. Read this manual thoroughly before using the balance and keep it at hand for future reference.

1.1. About This Manual

This manual consists of the following five parts:

- Basic operationDescribes precautions, the balance's construction and basic operation.
- Adapting to the environmentDescribes response (and stability) adjustment to adapt to the environment where there is vibration or drafts, the way to maintain weighing precision in a variation of ambient temperature, calibration and calibration test.
- FunctionsDescribes functions of the balance.
- RS-232C serial interfaceDescribes the serial interface that can communicate with a computer that requests weighing data and controls the balance. This serial interface is for use with a computer or printer.
- MaintenanceDescribes maintenance, error codes, troubleshooting, specifications and options.

1.2. Features

- Automatic self calibration, using the internal mass, adapting to changes in temperature.
- Response adjustment adapting to drafts and/or vibration automatically.
- Memory function to store weighing data and calibration data.
When weighing data is stored only, 200 data can be stored in maximum.
Interval memory mode to store the weighing data periodically.
- Good laboratory practice (GLP) data can output using the RS-232C serial interface.
- A built-in clock and calendar that can add the time and date to the output data.
- Underhook, available as an option, for measuring density and weighing magnetic materials.
- Multiple weighing units with most of the common units used around the world.
- Density mode for calculating the density of a solid.
- Standard RS-232C serial interface to communicate with a computer.
Windows communication tools software (WinCT) to allow easy communication with Windows.

1.3. Compliance

1.3.1. Compliance With FCC Rules

Please note that this equipment generates, uses and can radiate radio frequency energy. This equipment has been tested and has been found to comply with the limits of a Class A computing device pursuant to Subpart J of Part 15 of FCC rules. These rules are designed to provide reasonable protection against interference when equipment is operated in a commercial environment. If this unit is operated in a residential area, it may cause some interference and under these circumstances the user would be required to take, at his own expense, whatever measures are necessary to eliminate the interference.

(FCC = Federal Communications Commission in the U.S.A.)

1.3.2. Compliance With EMC Directives

CE This device features radio interference suppression in compliance with valid EC Regulation 89/336/EEC.

2. Unpacking the Balance

Unpack the balance carefully. Keep the packing material to be used for transporting the balance in the future. See the illustrations to confirm that everything is contained.

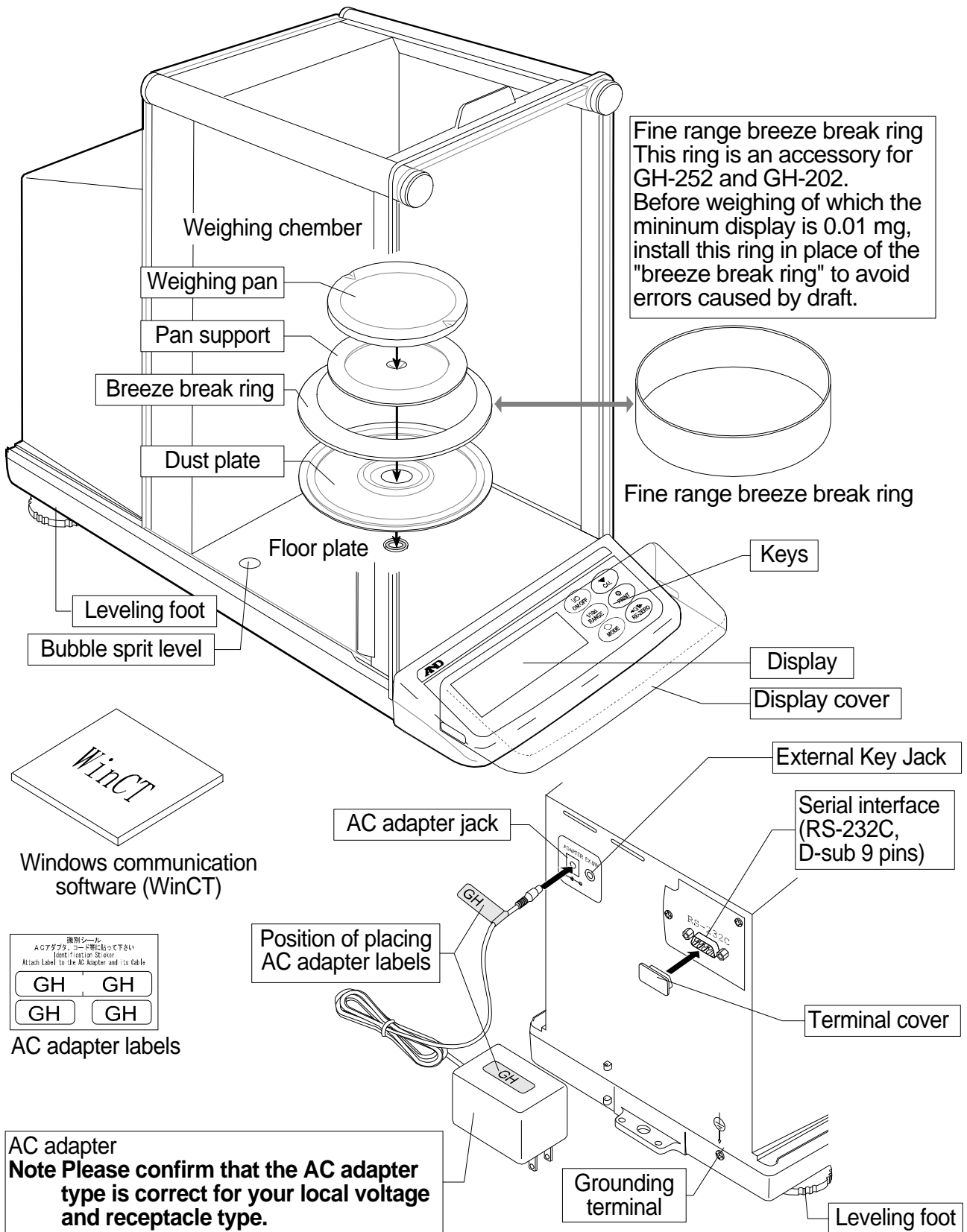

2.1. Installing The Balance

Install the balance as follows:

- 1 Consider the section "3. Precautions " for installing your balance. Place the balance on a firm weighing table.
- 2 Assemble the "Dust Plate", "Breeze Break Ring" and "Weighing Pan" on your balance. There is a reference illustration on the previous page.
- 3 Adjust the level of the balance using the leveling feet. Ground the balance chassis for discharging static electricity if you have a static problem.
- 4 Please confirm that the adapter type is correct for your local voltage and power receptacle type.
- 5 Connect the AC adapter to the balance. Warm up the balance for at least one hour with nothing on the weighing pan.
- 6 Calibrate the balance before use. Refer to "8. Calibration".

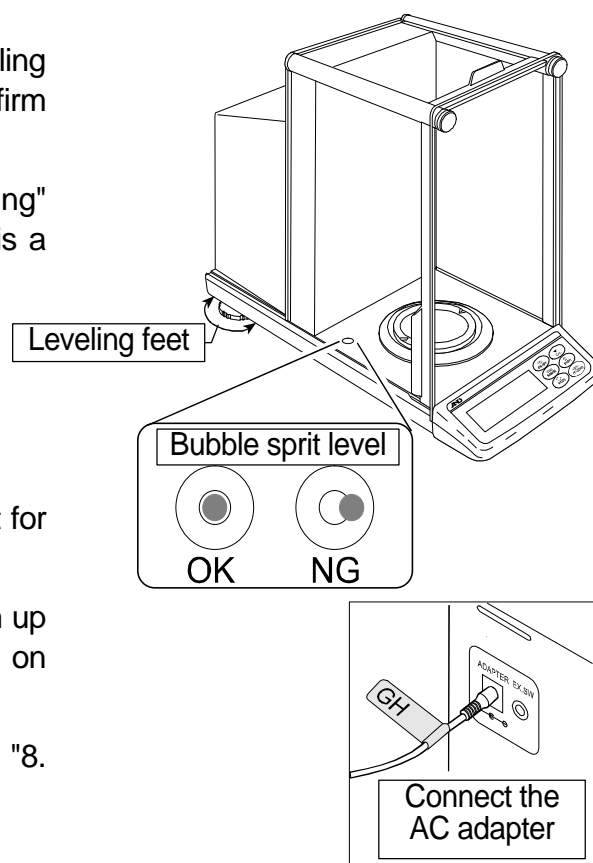

3. Precautions

3.1. Before Use

To ensure that you get the most from your balance, please try to follow these conditions as closely as possible.

- Please confirm that the AC adapter type is correct for your local voltage and receptacle type.
- Ensure a stable power source when using the AC adapter.
- The best operating temperature is about 20°C / 68°F at about 50% Relative Humidity.
- The weighing room should be free of dust.
- The weighing table should be solid and free from vibration, drafts (such as frequently opening doors or windows) and as level as possible.
- Corners of rooms are best as they are less prone to vibrations.
- Do not install the balance near heater or air conditioners.
- Do not install the balance in direct sunlight.
- Do not use the balance near other equipment which produces magnetic fields.
- Keep the balance level by using the bubble spirit level.
- Calibrate the balance before using and after moving it to another location.
- Please warm-up the balance for at least one hour. Plug-in the AC adapter as usual.

⚠ Do not place or use the balance where there is flammable or corrosive gas present.

3.2. During Use

Note the following items to get accurate weighing data.

- Discharge static electricity from the weighing material. When weighing sample (plastics, insulator, etc.) could have a static charge, the weighing value is influenced. Ground the balance, and
 - Eliminate the static electricity by AD-1683 as an accessory.
 - Or try to keep the ambient humidity above 45%RH.
 - Or use the metal shield case.
 - Or wipe plastic sample with the wet cloth.
- This balance uses a strong magnet as part of the balance assembly, so please use caution when weighing magnetic materials. If there is a problem, use the underhook (on the bottom of the balance) to suspend the material away from the influence of the magnet.
- Cancel the temperature difference between the weighed sample and the environment. When a sample is warmer (cooler) than the ambient temperature, the sample will lighter (heavier) than true mass. This error is due to the rising (falling) draft next the sample.
- Make each weighing gently and quickly to avoid errors due to changes in the environmental conditions.
- Before weighing of which the minimum display is 0.01 mg for GH-252 and GH-202, the "fine range breeze break ring" can be installed in place of the "breeze break ring" to avoid errors caused by draft.
- Do not drop things upon the weighing pan, or put a weight beyond the range of the balance on the weighing pan.
- Do not use a sharp instrument (such as a pencil or ball point pen) to press the keys, use your finger only.
- Press the **RE-ZERO** key before each weighing to prevent possible errors.
- Calibrate the balance periodically so as to eliminate possible errors.
- Take into consideration the affect of air buoyancy on a sample when more accuracy is required.
- Avoid that a foreign matter (dust, liquid or metal fragments) invades into the inside balance.
- Operate your balance gently. Shorten the operation time as much as possible (Opening and closing door, putting and removing sample). Use a pair of tweezers (pincette) to avoid temperature changes due to heat from inserting your hand into the weighing chamber.

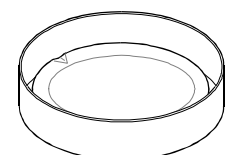
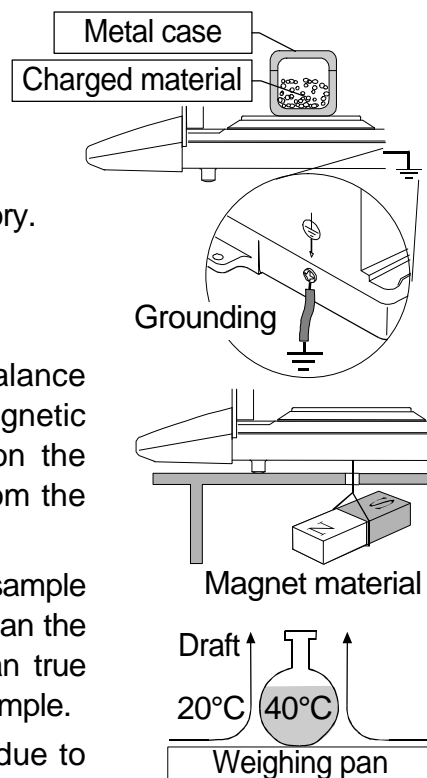

Fine range breeze break ring

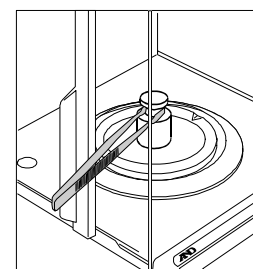
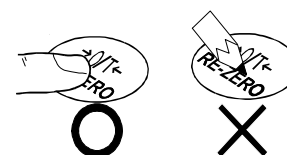
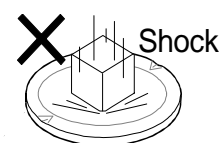

3.3. After Use

- Avoid mechanical shock to your balance.
- Do not disassemble the balance. Contact your local A&D dealer if your balance needs service or repair.
- Do not use solvents to clean the balance. For best cleaning, wipe with a dry lint free cloth or a lint free cloth that is moistened with warm water and a mild detergent.
- Avoid that a foreign matter (dust, liquid or metal fragments) invades into the inside balance.

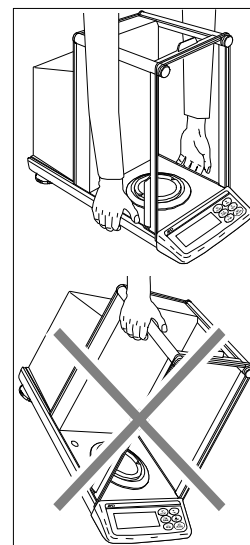

3.4. Power Supply

- Do not remove the AC adapter while the internal mass is in motion, for example, right after the AC adapter is connected, or during calibration using the internal mass. If the AC adapter is removed under the conditions described above, the internal mass will be left unsecured, that may cause mechanical damage when the balance is moved. Before removing the AC adapter, press the **ON:OFF** key and confirm that zero is displayed in weighing mode.
- When the AC adapter is connected, the balance is in the standby mode if the standby indicator is on. This is a normal state and does not harm the balance. For accurate weighing, we recommend that you plug in your balance for at least an hour before use so it can warm up.

4. Display Symbols and Key Operation

Display

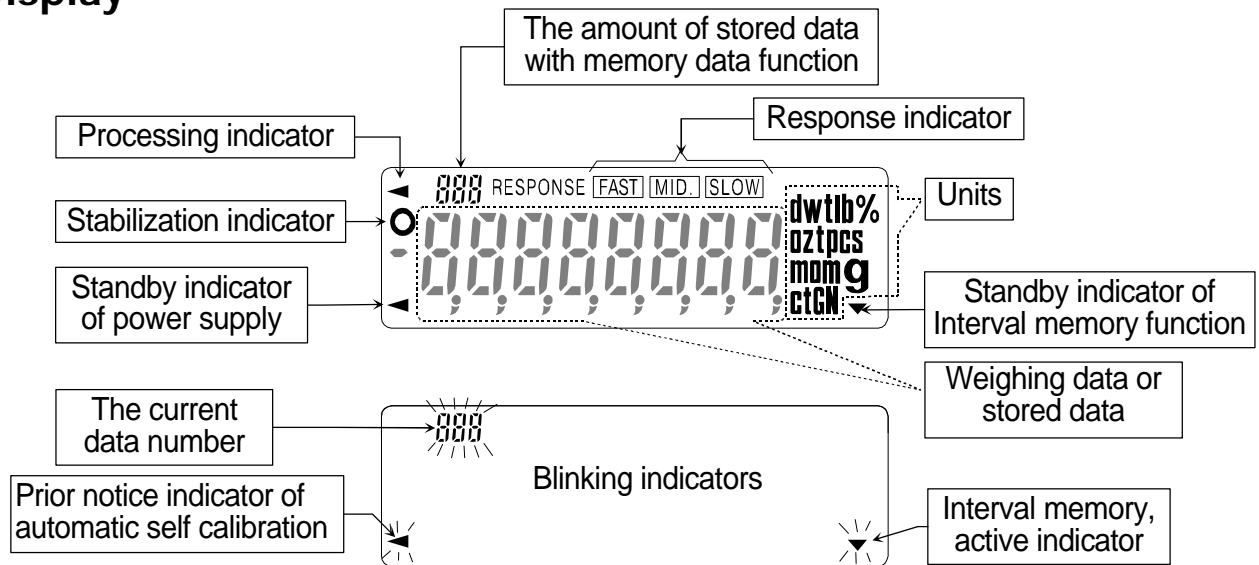

Key Operation

- Press and release the key immediately" or "Click the key".....
- Press and hold the key.....

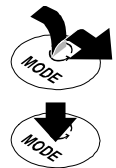

Key	When pressed and released	When pressed and held
	The key to turn the display ON and OFF. The standby indicator is displayed when the display is turned off. The weighing mode is enabled when the display is turned on. This key is available anytime. Pressing the key during operation will interrupt the operation and turn the display OFF.	
	<ul style="list-style-type: none"> □ In the weighing mode, the key to turn the minimum weighing value ON and OFF. □ In the counting or percent mode, the key to enter the sampling mode. 	The key to enter the function table mode. Refer to "10. Function Table".
	The key to switch the preset weighing units stored in the function table. Refer to "5. Weighing Units".	The key to perform automatic response adjustment.
	The key to perform calibration using the internal mass.	The key to display other items of the calibration menu.
	The key to store the weighing data in memory or outputs to a printer or personal computer depending on the function table settings. (Factory setting = output)	No function at the factory setting. By changing the function table: <ul style="list-style-type: none"> □ "Title block" and "End block" for GLP report are outputted. □ The data memory menu is displayed.
	The key to set the display to zero.	

5. Weighing Units

5.1. Units

- All weighing units and weighing modes are as follows:

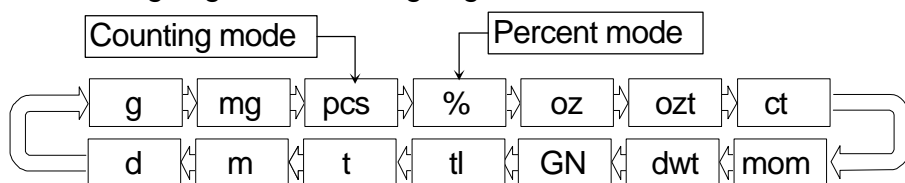

Density mode

- To use this mode, it must be stored in the function table as described on the next page. For details about this mode, refer to "14. Density Measurement".
- To select this mode, press the **MODE** key until the processing indicator ◀ blinks with the unit "g" displayed.

- A unit or mode can be selected and stored in the function table as described in "5.2. Changing the Units".
- If the law in your area permits, you may use all of the units. You can disable the units that you don't regularly use. And you are able to turn them back on.
- If a weighing mode (or unit of mass) has been turned off, that mode or unit will be missing in the sequence. Tael has four varieties, one of which can be selected and installed at the factory.
- To select a unit or mode for weighing, press the **MODE** key.
- For details about the units and modes, see the table below:

Name (unit, mode)	Abbreviation	Display unit	Conversion factor
Gram	g	g	1 g
milli-gram	mg	mg	0.001 g
Counting mode	pcs	pcs	-
Percent mode	%	%	-
Ounce (Avoir)	oz	oz	28.349523125 g
Troy Ounce	ozt	ozt	31.1034768 g
Metric Carat	ct	ct	0.2 g
Momme	mom	mom	3.75 g
Pennyweight	dwt	dwt	1.55517384 g
Grain (UK)	GN	GN	0.06479891 g
Tael (HK general, Singapore)	tl	tl	37.7994 g
Tael (HK jewelry)			37.429 g
Tael (Taiwan)			37.5 g
Tael (China)			31.25 g
Tola (India)	t	t	11.6638038 g
Messghal	m	m	4.6875 g
Density mode	d	Refer to "14. Density Measurement"	

5.2. Changing the Units

- The units or modes can be selected and stored in the function table. The sequence of displaying them can be arranged so as to fit the frequency of use in the function table.

- Press and hold the **RANGE** key until **ba5fnc** of the function table is displayed in the weighing mode, then release the key.
- Press the **RANGE** key several times to display **Unit**.
- Press the **PRINT** key to enter the unit selection mode.
- Specify a unit or mode in the order to be displayed using the following keys.
 - RANGE** key To display the units sequentially.
 - RE-ZERO** key To specify a unit or mode.

The stabilization indicator  appears when the displayed unit or mode is specified.

Examples

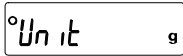
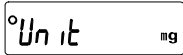
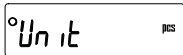
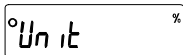
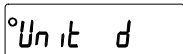
Unit		Display
Gram	g	
Milli-gram	mg	
Counting mode	pcs	
Percent mode	%	
Density mode	d	

- Press the **PRINT** key to store the units or modes. The balance displays **End** and then displays the next menu item of the function table.
- Press the **CAL** key to exit the function table. Then the balance returns to the weighing mode with the selected unit.

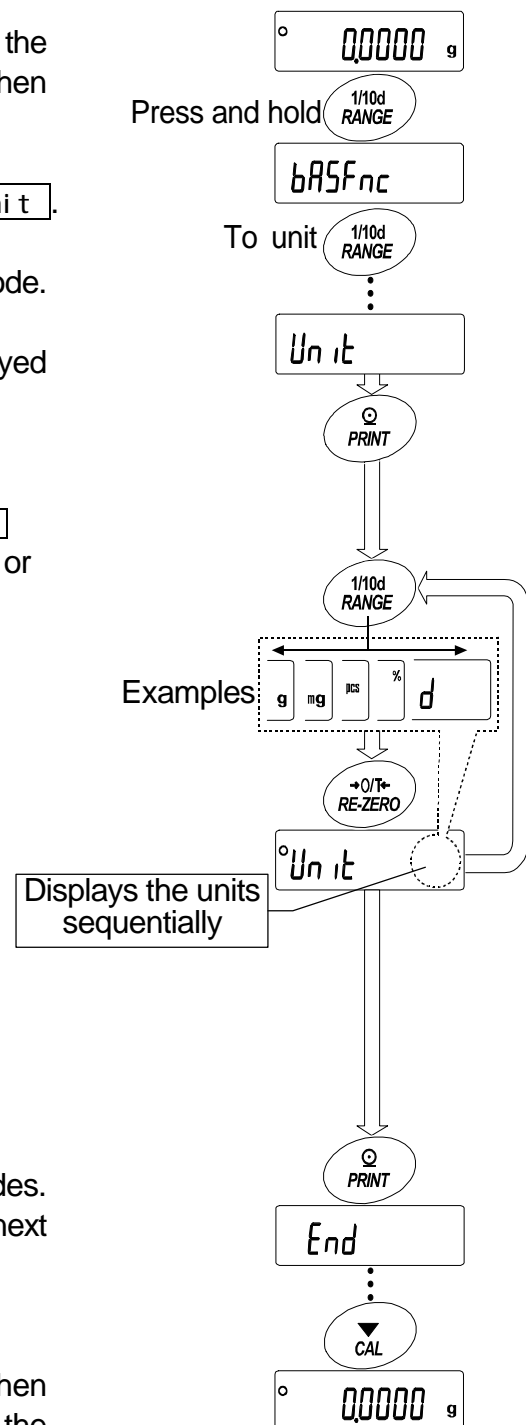

6. Weighing

Cautions For The Weighing Operation

- Press the **RE-ZERO** key to prevent possible error before putting sample on the weighing pan each time.
- Put sample to the center of the weighing pan gently.
- Temperature changes during measurement may cause weighing error.
- Shorten the operation time as much as possible. (Opening and closing door, putting and removing sample)
- Use a pair of tweezers (pincette) to avoid a temperature change that is due to having your hand in the weighing chamber.
- Electrified material or magnetic body may cause a weighing error.
- Do not press keys with a sharp instrument (such as a pencil or ball point pen).
- Do not drop things on the pan, or place a weight on the pan that is beyond the weighing range of the balance.
- Calibrate your balance periodically to maintain weighing accuracy. Refer to section "8. Calibration".
- Keep the area clean and dry.
- Consider section "3. Precautions" for weighing operation.
- For precision weighing, keep the AC adapter connected to the balance.

6.1. Basic Operation (Gram Mode)

Read section "4. Display symbols and Key operation" before operation.

Note When turning on the balance that is put the container on the pan, display becomes zero by tare function. automatically.

- 1 Turn on the balance using the **ON:OFF** key.
- 2 Select a preset unit (of g or mg) using the **MODE** key.
- 3 Put the container on the weighing pan, if necessary.

Press the **RE-ZERO** key to cancel net weight. Then zero is displayed.

Container : A vessel placed on the pan, but not to be included in the weighing data.

- 4 Place sample on the pan or in the container.
- 5 Wait for the stabilization indicator **○** and read the value.
- 6 Remove the sample and container from the pan.

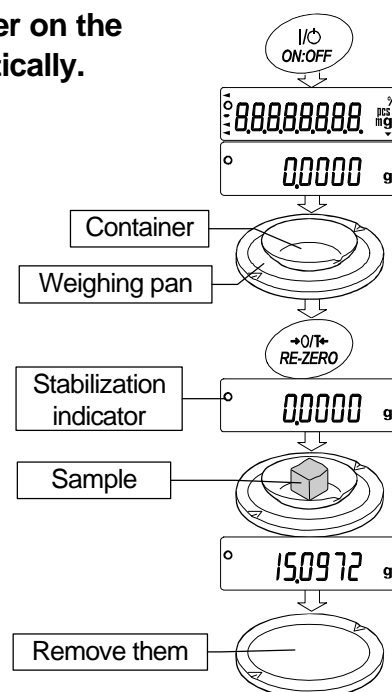

6.2. Dual Range

	Weighing range		Available minimum display
	GH-252	GH-202	
Precision range	0g to 101 g	0g to 51 g	0.01 mg 0.1 mg 1 mg
Standard range	101g to 250 g	51 g to 220 g	0.1 mg 1 mg

GH-252 and GH-202 are equipped with two ranges of "precision range" and "standard range".

- The range is switched automatically depending on the value displayed. Pressing the **RE-ZERO** key allows weighing in the precision range, regardless of the tare value.
- Pressing the **RANGE** key, the range can be switched these ranges alternately.

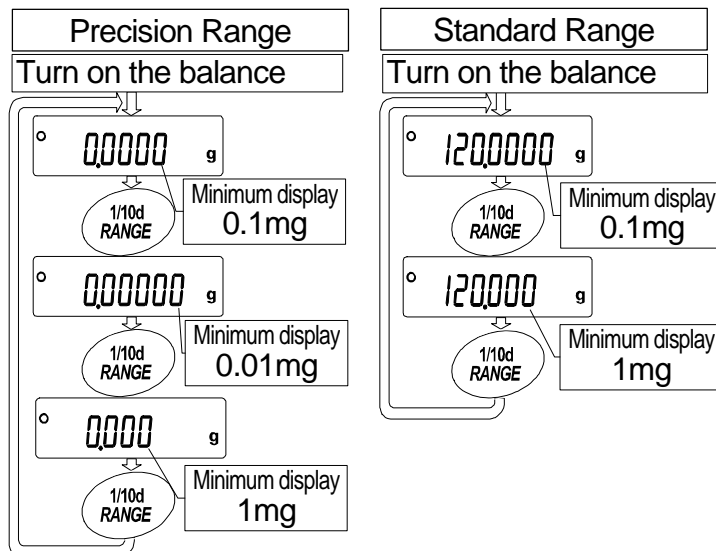

- When putting and weighing the sample with precision range of minimum display 0.01 mg, minimum display is changed to 0.1 mg of standard range. When removing the sample, minimum display is changed to 0.01 mg of precision range automatically.

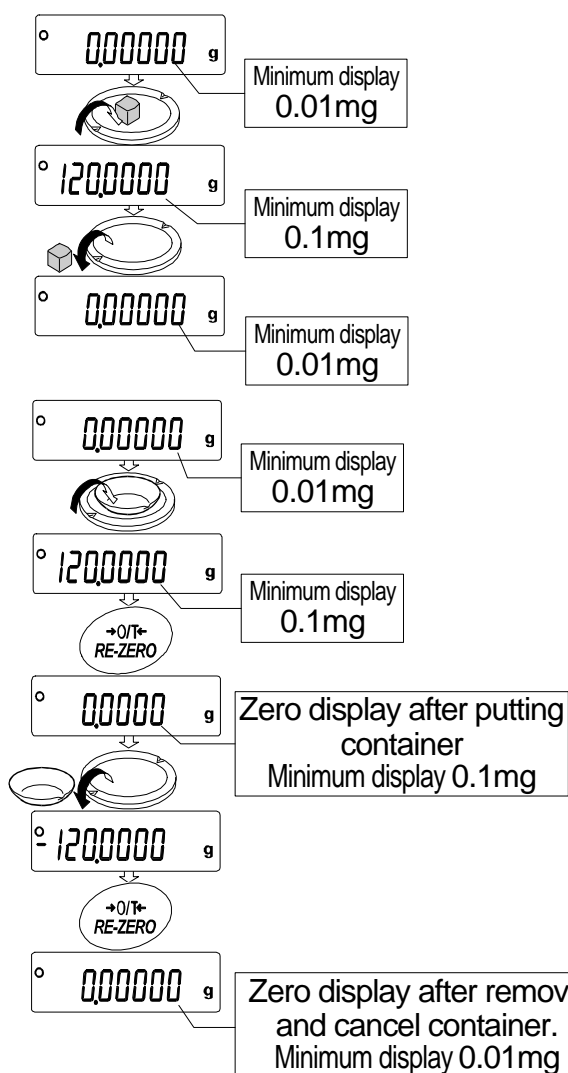

- When a tare weight (container mass value) exceeds precision range, even if net weight is within precision range, 0.01 mg of precision range can not be selected for minimum display. In order to select 0.01 mg of precision range, remove tare weight and press the **RE-ZERO** key to cancel it.

- When a minimum display 0.1mg or 1mg is selected by the **RANGE** key, even if changing range, minimum display is maintained.

6.3. Counting Mode (PCS)

- This is the mode to determine the number of objects in a sample based on the standard sample unit mass. The unit mass means an average mass of the samples. The smaller the variation in the samples, the more accurate the count will be. The balance is equipped with the Automatic Counting Accuracy Improvement (ACAI) function to improve the counting accuracy.

Note If the sample unit mass variable, the difference from sample to sample, is too large, it may cause a counting error.

Selecting The Counting Mode

- 1 Press the **MODE** key to select the unit **pcs** (counting mode).

Storing A Sample Unit Mass (Weighing Input Mode)

- 2 Press the **RANGE** key to enter the sample unit mass storing mode.

- 3 To select the number of samples using the **RANGE** key. It may be set to 10, 25, 50 or 100.

Advise A greater number of samples will yield more accurate counting result.

- 4 Place a container on the weighing pan, if necessary. Press the **RE-ZERO** key to cancel the weight (tare). The number specified in step 3 appears.

Example: **25.0** pcs is displayed if 25 is selected in step 3.

- 5 Place the number of samples specified on the pan. In this example, 25 pieces.

- 6 Wait for the stabilization indicator to come on. Press the **PRINT** key to calculate and store the unit mass. Then the balance displays **25 pcs** and is set to count samples with this unit mass. (The sample unit mass stored, even if the AC adapter is removed, is maintained in non-volatile memory.) To improve the accuracy of the unit mass, proceed to step 8.

Notes

- If the balance judges that the mass of the samples is too light (under 0.0001g) and can not be stored as the unit mass, it displays **1.0**.
- If the balance judges that the mass of the samples is too light to acquire accurate weighing, it displays an error requiring the addition of more samples to the specified number.

Example: **50 - pcs** appears, requiring 25 more samples. Add 25 samples and press the **PRINT** key. When the unit mass is stored correctly, the balance proceeds to the counting mode.

Counting Operation

- 7 Place the samples to be counted on the pan.

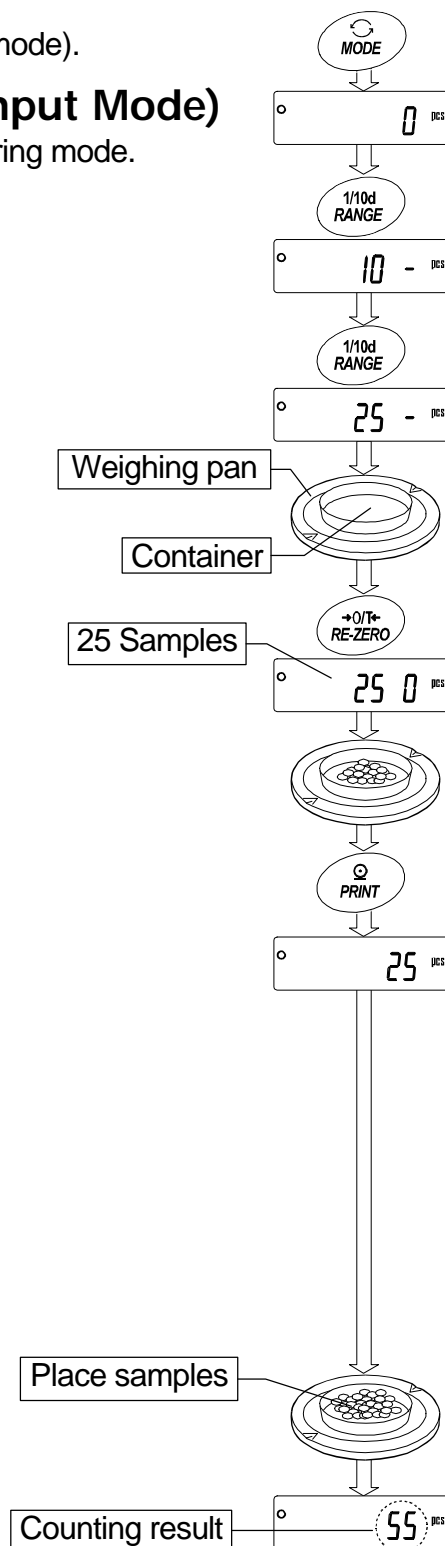

Counting Mode Using The ACAI Function

The ACAI is a function that improves the accuracy of the unit mass automatically by increasing the number of samples as the counting process.

ACAI: Automatic Counting Accuracy Improvement

- 8 If a few more samples are added, the processing indicator turns on. To prevent an error, add three or more. The processing indicator does not turn on if overloaded. Try to add the same number of samples as displayed.
- 9 The balance re-calculates the unit mass while the processing indicator is blinking. Do not touch the balance or samples on the pan until the processing indicator turns off.
- 10 Counting accuracy is improved when the processing indicator turns off. Each time the above operation is performed, a more accurate unit mass will be obtained. There is no definite upper limit of ACAI range for the number of samples exceeding 100. Try to add the same number of samples as displayed.
- 11 Remove all the samples used in ACAI and proceed with the counting operation using the improved unit mass.

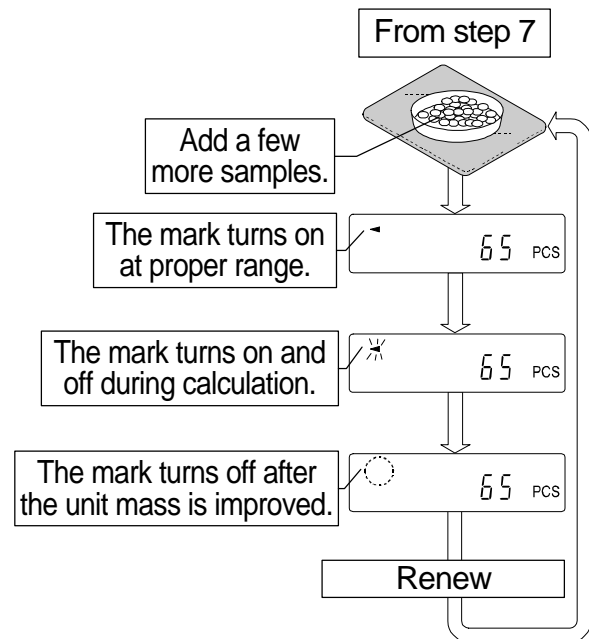

Note ACAI will not function on the unit mass entered using the keys, or digital input mode.

6.4. Percent Mode (%)

The percent mode displays the weighing value in percentage compared to a 100% reference mass and is used for target weighing or checking the sample variance.

Selecting The Percent Mode

- 1 Press the **MODE** key to select the unit **%** (Percent mode).
If the percent mode can not be selected, refer to "5. Weighing Units".

Storing The 100% Reference Mass

- 2 Press the **RANGE** key to enter the 100% reference mass storing mode.
Even in the storing mode, pressing the **MODE** key will switch to the next mode.
- 3 Place a container on the weighing pan, if necessary. Press the **RE-ZERO** key to cancel the weight (tare). The balance displays **100 0 %**.
- 4 Place the sample to be set as the 100% reference mass on the pan or in the container.
- 5 Press the **PRINT** key to store the reference mass. The balance displays **10000 %**. (The decimal point position depends on the reference value. The reference mass stored, even if the AC adapter is removed, is maintained in non-volatile memory.)

Note

- Position of decimal point can be changed by 100% mass.

100% mass	Minimum display
0.0100g to 0.0999g	1%
0.1000g to 0.9999g	0.1%
1.0000g to weighing capacity	0.01%

- If the balance judges that the mass of the sample is too light (under 0.01g) to be used as a reference, it displays **1 0** .
- A 100%mass can be stored in the balance without power supply.

- 6 Remove the sample.

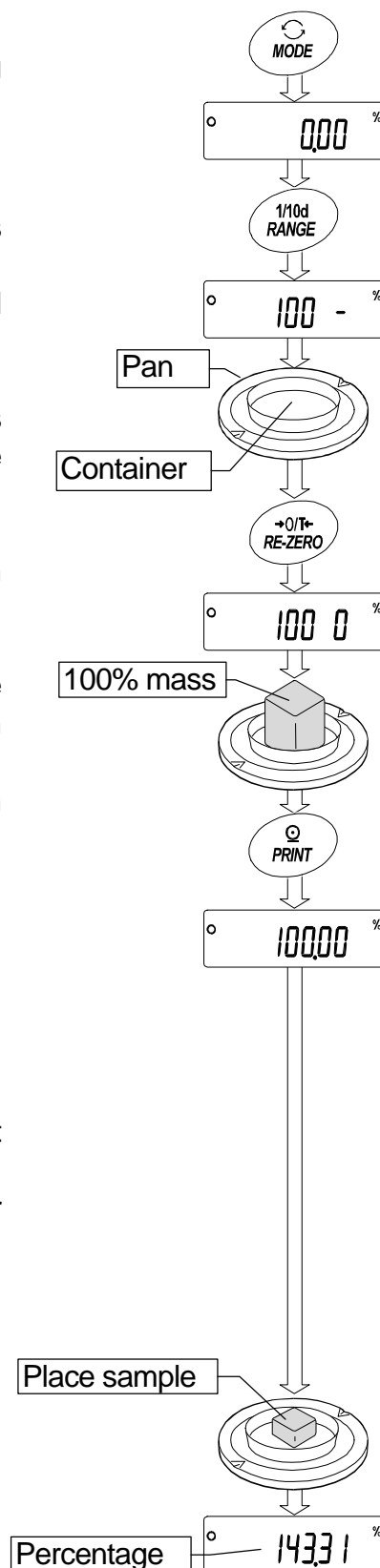

Reading The Percentage

- 7 Place a sample to be compared to the reference mass on the pan. The displayed percentage is based on the 100% reference mass.



7. Response Adjustment

This function stabilizes the weighing value, reducing the influence on weighing that is caused by drafts and/or vibration at the place where the balance is installed. This function adjusts by automatically analyzing the environment or by hand-operation. The function has three stages as follows :

Indicator	Parameter	Response	Stability
FAST	Cond 0	Fast response,  Sensitive value	Stable value 
MID.	Cond 1		
SLOW	Cond 2	Slow response, Stable value	

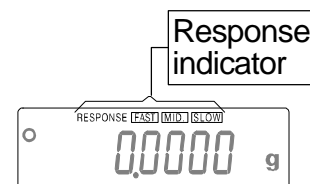

7.1. Automatic Response Adjustment

This function automatically updates the response adjustment by analyzing the influence of the environment using the internal mass.

- 1 Press and hold the **MODE** key until **RESPONSE** is displayed, and then release the key.
- 2 The balance automatically sets the response characteristic.
Caution Do not allow vibration or drafts to affect the balance during adjustment.
- 3 After automatic adjustment, the balance displays the updated response indicator and returns to the weighing mode.

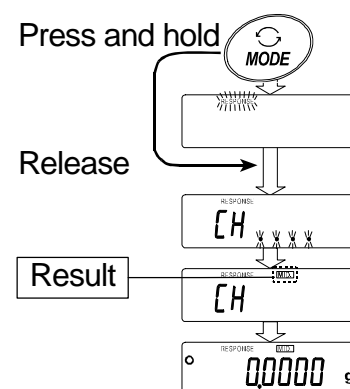

Note

- If the automatic response adjustment fails, the balance displays **CH ng**. Check the ambient conditions such as breeze and vibration, also check the weighing pan. Then, perform the adjustment again. To return to the weighing mode, press the **CAL** key.
- If there is matter on the weighing pan, the balance displays **CH 0**. Remove them from the pan. To return to the weighing mode, press the **CAL** key.

Advise

If the automatic response adjustment is not helpful, try "7.2. Manual Response Adjustment".

7.2. Manual Response Adjustment

- 1 Press and hold the **MODE** key until **RESPONSE** is displayed. And then, press the **MODE** key again quickly.
- 2 Select a stage of the response adjustment using the **MODE** key. Either **FAST**, **MID.** or **SLOW** can be selected.
- 3 The balance automatically returns to the weighing mode after a few

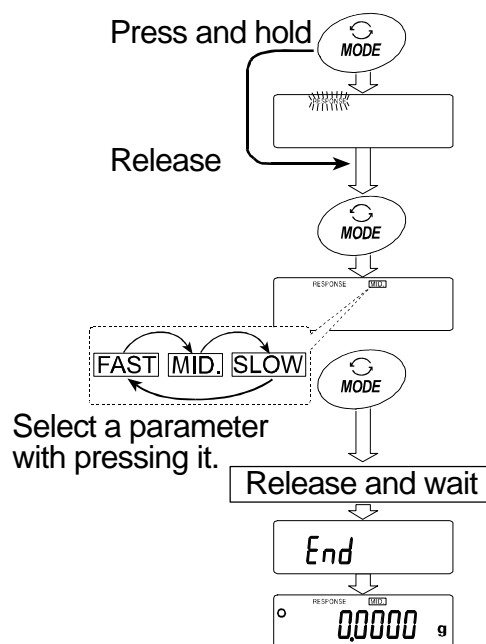

Advise

If the automatic response adjustment is not helpful, specify a parameter of "Condition (Cond)" of "Environment, Display (ba5fnc)" in with key operation.

8. Calibration

8.1. Calibration Group

Calibration

- Automatic self calibration (Calibration due to changes in temperature)
- Calibration using the internal mass (One-touch calibration)
- Calibration using an external weight that you have

Calibration Test

- Calibration test using the internal mass
- Calibration test using target mass that you have

Correction of the internal mass value

- Correction of the internal mass value

Caution

- Do not allow vibration or drafts to affect the balance during calibration.
- Calibration test does not perform calibration.
- To output the data for GLP using the RS-232C interface, set "GLP output (info)" of "Data output (dout)". Refer to "10. Function Table". Time and date can be added to GLP report. If the time or date is not correct, adjust them. Refer to "10.7 Clock and Calendar Function".
- Calibration test is available only when "GLP output (info)" of "Data output (dout)" is set.
- The calibration and calibration test data can be stored in memory. To store them, set "Data memory (data)". Refer to "12. Data Memory" for details.

Caution On Using An External Weight

- The accuracy of an external weight can influence the accuracy of weighing. Select an appropriate weight as listed below:
- Select a mass for calibration and calibration test from the following table.

Model	Usable calibration mass	Adjustable range
GH-120	50g, 100g*	-15.0mg to +15.9mg
GH-200	100g, 200g*	
GH-300	100g, 200g* , 300g	
GH-202, GH-252	20g, 50g, 100g, 200g*	-15.00mg to +15.99mg

The calibration mass in **bold type**: factory setting

The calibration mass value can be adjusted within the range above.

Display



This indicator means "In process of measuring calibration data".

Do not allow vibration or drafts to affect the balance while the indicator is displayed.

About the internal mass

- The internal mass may change due to corrosion or other damage caused by the operating environment, or due to aging. Check the internal mass periodically and correct the internal mass value if necessary.

8.2. Automatic Self Calibration

Automatic self calibration due to changes in temperature

This function automatically calibrates the balance when the balance detects an ambient temperature change. If GLP output is selected in the function table, the balance outputs the calibration report or stores the data in memory. Automatic self calibration functions even if the display is turned off (standby state). Refer to "9-1. Permit Or Inhibit" for the operation.

Caution

- **When using automatic self calibration, do not put something on the weighing pan.**
- **If something is on the weighing pan, the balance decides that it is in use and does not perform automatic self calibration.**
- **When weighing a light sample or installing the balance in a system, turn off automatic self calibration.**

Note When turning on the balance with nothing on the pan, if putting heavier sample than 0.5 g, the balance detects the state that a sample is put on the pan.



The mark ◀ is "prior notice indicator of automatic self calibration".

When the balance detects a change in ambient temperature, this indicator blinks and automatic self calibration is required. If the balance is not used for several minutes with this indicator blinking, the balance performs automatic self calibration. The environment will affect the time that the indicator blinks.

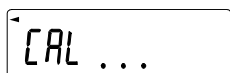

The balance is measuring calibration data. Do not allow vibration or drafts to affect the balance while this indicator is displayed. After calibration, the balance returns to indicate the previous display.

Advise

The balance can be used while the indicator blinks. But, it is recommended that to maintain the accuracy, stop using the balance and confirm that there is nothing on the pan and allow the balance to perform self calibration.

8.3. One-Touch Calibration

This function calibrates the balance using the internal mass.

The only operation required is to press the **CAL** key.

- 1 Connect the AC adapter and warm up the balance for at least one hour with nothing on the weighing pan.
- 2 Press the **CAL** key to display **Cal in**.
- 3 The balance performs calibration using the internal mass. Do not allow vibration or drafts to affect the balance.
- 4 The balance displays **end** after calibration. If the GLP output is set, the balance displays **glp** and outputs the calibration report using the RS-232C interface or stores the data in memory. Refer to "GLP output (info)" and "Data memory (data)" of the function table.
- 5 The balance will automatically return to the weighing mode after calibration.
- 6 Confirm weighing accuracy using calibration test (CC in).

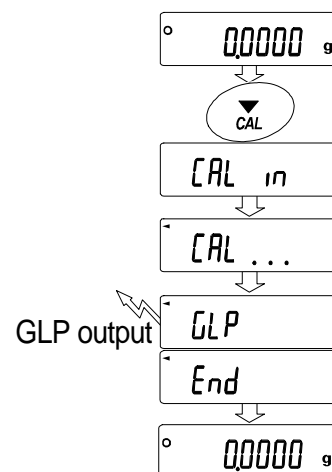

8.4. Calibration Test Using The Internal Mass

This function tests the balance accuracy using the internal mass. (Balance isn't calibrated)
When the GLP output is set, the calibration test report is output or stored.

- 1 Connect the AC adapter and warm up the balance at least one hour.
- 2 Press and hold the **[CAL]** key until **CC in** is displayed.
- 3 The balance measures the zero point. Prevent vibration and drafts to affect the balance.
- 4 The measured zero point data is displayed.
- 5 The balance measures the full scale data. Prevent vibration and drafts to affect the balance.
- 7 The full scale data is displayed. The tolerance of the full scale data is $\pm 0.2\text{mg}$.

Model	Full scale data
GH-120	100.000 g
GH-200, GH-300, GH-202, GH-252	200.000 g

- 8 When the GLP output is set, the calibration test report is output or stored.
 - Refer to "GLP output (info)" and "Data memory (data)" of the function table.
 - Zero point data and full scale data is displayed (or outputted) in unit of 0.0001g.
- 8 The balance automatically returns to the weighing mode.

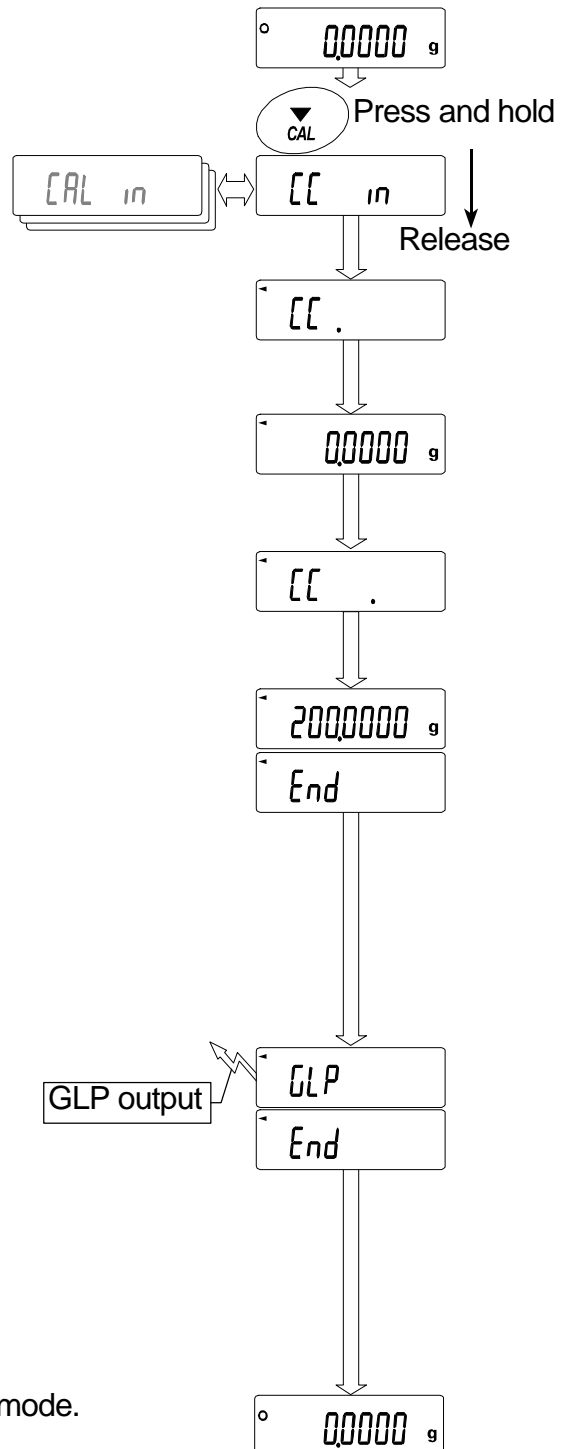

8.5. Calibration Using An External Weight

This function calibrates the balance using an external weight.

- 1 Connect the AC adapter and warm up the balance for at least one hour with nothing on the weighing pan.
- 2 Press and hold the **[CAL]** key until **Cal out** is displayed, then release the key.
- 3 The balance displays **Cal 0**.
 - If you want to change the calibration mass, press the **[RANGE]** key and proceed to step 4.
 - If you use the calibration mass value stored in the balance, proceed to step 5.
- 4 Specify the calibration mass value as follows:
 - [RANGE]** key The key to switch blinking figures.
 - [RE-ZERO](+)**key ... The key to select the calibration mass or adjust the mass value. Refer to page 19.
 - [MODE](-)**key The key to store the new mass value.
 - [PRINT]** key The key to cancel the operation and return to **Cal 0**.
- 5 Confirm that there is nothing on the pan and press the **[PRINT]** key. The balance measures the zero point. Do not allow vibration or drafts to affect the balance. The balance displays the calibration mass value.
- 6 Place the displayed calibration weight on the pan and press the **[PRINT]** key. The balance measures the calibration mass. Do not allow vibration or drafts to affect the balance.
- 7 The balance displays **end**. Remove the weight from the pan.
- 8 If the "GLP output (info)" the function table is set, the balance displays **glp** and outputs or stores "Calibration Report". Refer to "11.2. GLP Report" for details.
- 9 The balance will automatically return to the weighing mode.
- 10 Place the calibration weight on the pan and confirm that the value displayed is correct. If it is not within the range, check the ambient conditions such as breeze and vibration also check the weighing pan. Then, repeat steps 1 to 10.

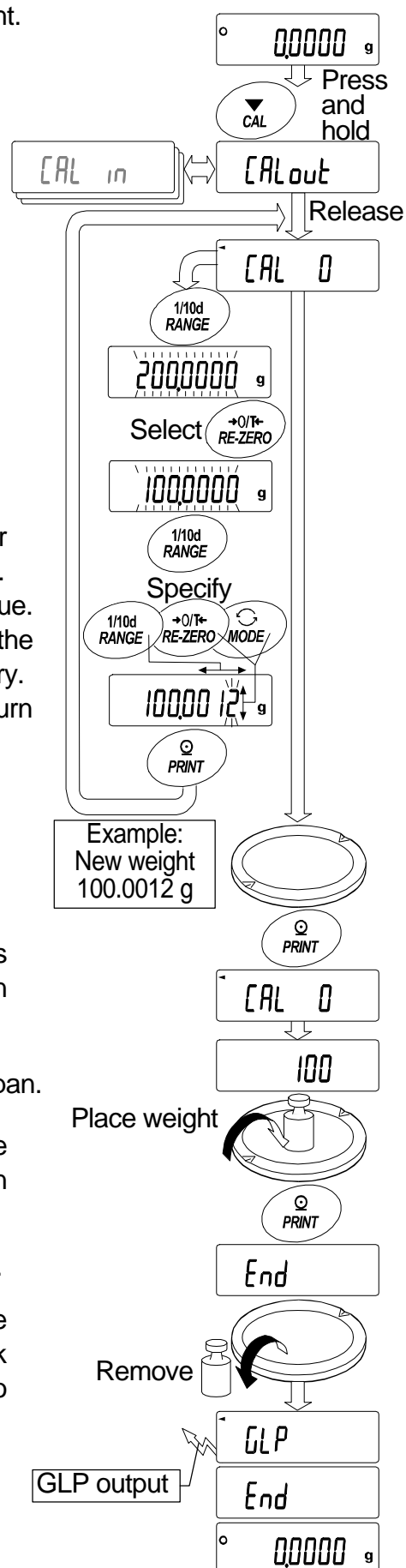

8.6. Calibration Test Using An External Weight

This function tests the weighing accuracy using an external weight. Calibration test report can be output or stored with "GLP output (info)" (Calibration test does not perform calibration).

- 1 Connect the AC adapter and warm up the balance for at least one hour with nothing on the weighing pan.
- 2 Press and hold the **CAL** key until **CC out** is displayed, then release the key.
- 3 The balance displays **CC 0**.
 - If the target mass is changed, press the **RANGE** key and proceed to step 4. A list of usable weights is on 19 page.
 - If current target mass value is used, proceed to step 5.
- 4 Specify the target mass value as follows:
 - RANGE** key The key to switch blinking figures.
 - RE-ZERO**(+)**key** The key to select the target mass or adjust the mass value. Refer to page 19.
 - MODE**(-)**key**
 - PRINT** key The key to store the new mass value. Even if the AC adapter is removed, the data is maintained in non-volatile memory.
 - CAL** key The key to cancel the operation and return to **CC 0**.
- 5 Confirm that there is nothing on the pan and press the **PRINT** key. The balance measures the zero point and displays the measured value. Do not allow vibration or drafts to affect the balance. The balance displays the target mass value.
- 6 Place the displayed target mass on the pan and press the **PRINT** key. The balance measures the target mass and displays the measured value. Do not allow vibration or drafts to affect the balance.
- 7 The balance displays **end**. Remove the weight from the pan.
- 8 The balance displays **glp** and outputs or stores "calibration test report. Refer to "11.2. GLP Report" of the function table for details.
- 9 The balance will automatically return to the weighing mode.

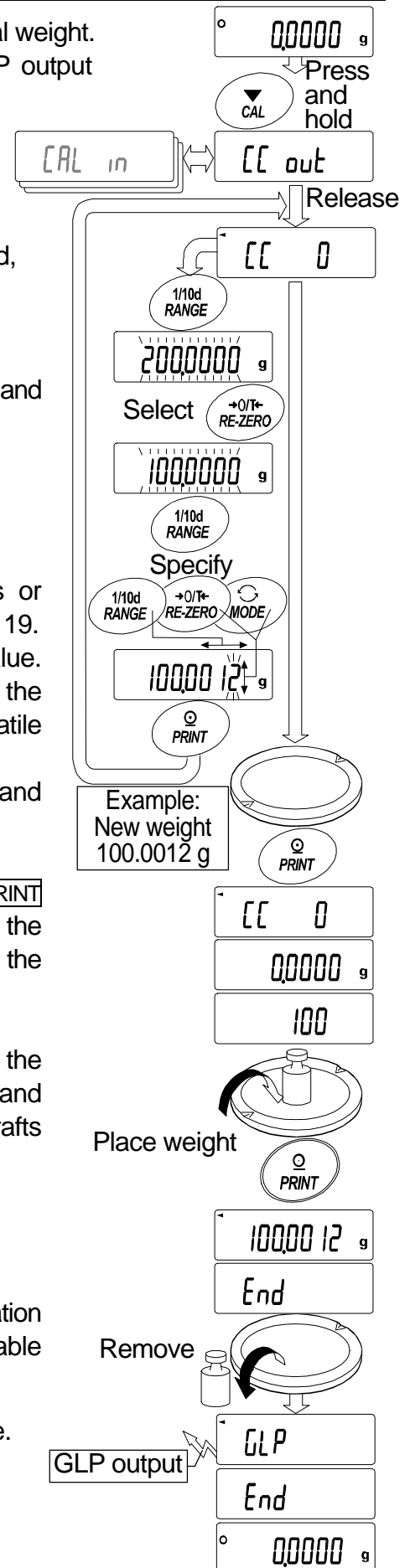

8.7. Correcting The Internal Mass Value

The balance can correct the internal mass value within the range shown below. This function corrects the internal mass value to conform to an external weight. The corrected mass value is maintained in non-volatile memory even if the AC adapter is removed. The internal mass value is corrected as follows:

Model	Target	Range
GH-120	100.000 g	±1.5 mg
GH-200	200.000 g	
GH-300		
GH-202		
GH-252		

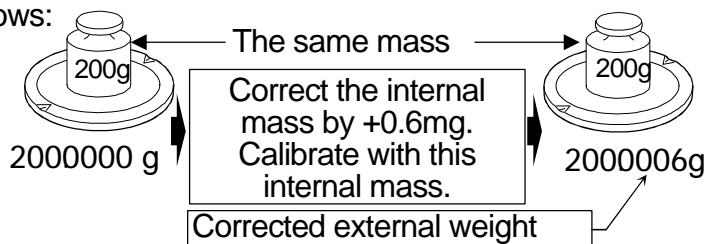

1 Calibrate the balance using the internal mass. (one-touch calibration)
Example: 200.0000 g is corrected to +0.6 mg (200.0006 g).

2 Press the **ON:OFF** key to turn off the display.

3 While pressing and holding the **PRINT** key and the **RANGE** key, press the **ON:OFF** key. The balance displays **p5**.

4 Press the **PRINT** key. Then the balance displays the function switches. Set the function table switch and internal mass correction switch to "1" as shown above using the following keys.

RANGE key..... The key to select blinking figure.

RE-ZERO key..... The key to change the value of the blinking figure..

PRINT key..... The key to store it and return to weighing mode.

CAL key..... The key to cancel current operation.

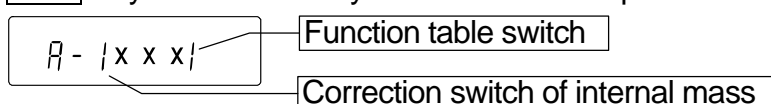

5 Press and hold the **RANGE** key to enter the function table and release the key when **ba5fnc** is displayed.

6 Press the **RANGE** key several times until **C5 in** is displayed, then release the key.

7 Press **PRINT** key. Correct the internal mass value using the following keys.

RE-ZERO(+)key .. The key to select the value.

MODE(-)key..... The key to select the value.

PRINT key The key to store the new value and display the next menu item of the function table.

CAL key..... The key to cancel this correction and display the next menu item of the function table.

8 Press the **CAL** key to return the weighing mode.

9 Press the **CAL** key to calibrate the balance using the internal mass.

10 Check the correction that has been performed properly with the external weight. If the value is incorrect, repeat the correction.

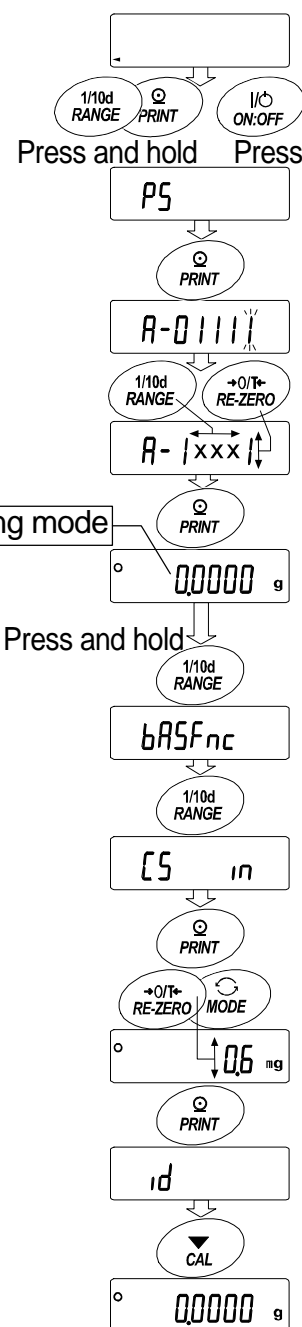

9. Function Switch And Initialization

9.1. Permit Or Inhibit

The balance stores parameters that must not be changed unintentionally (Example: Calibration data for accurate weighing, Data for adapting to the operating environment, Control data for the RS-232C interface). There are five switches for the purpose of protecting parameters. Each switch can select either "permit" or "inhibit". The "inhibit" protects parameters against unintentional operations.

- 1 Press the **ON:OFF** key to turn off the display.
- 2 While pressing and holding the **PRINT** key and the **RANGE** key, press the **ON:OFF** key to display **p5**.
- 3 Press the **PRINT** key. Then the balance displays the function switches.
- 4 Specify the switches using the following keys.

RANGE key..... The key to select blinking digit.

RE-ZERO key..... The key to change the parameter of the selected switch.

0 To inhibit changes. (Can not be used.)

1 To permit changes. (Can be used.)

PRINT key The key to store the new parameter and return to the weighing mode.

CAL key..... The key to cancel current operation and return to the weighing mode.

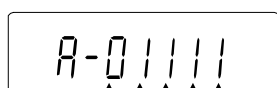

Function table

0 To inhibit changes to the function table.

1 To permit changes to the function table.

Calibration using the internal mass (One-touch calibration)

0 To inhibit calibration using the internal mass.

1 To permit calibration using the internal mass.

Calibration using the external weight

0 To inhibit calibration using the external weight.

1 To permit calibration using the external weight.

Automatic self calibration (due to changes of ambient temperature)

0 To inhibit automatic self calibration.

1 To permit automatic self calibration.

Internal mass correction

0 To inhibit correction.

1 To permit correction.

9.2. Initializing The Balance

This function returns the following parameters to factory settings.

- Calibration data
- Function table
- The sample unit mass value (counting mode),
100% reference mass value (percent mode)
- The data that is stored in the balance using the data memory function
- External calibration weight and target mass value
- Function switch settings ("25. Permit Or Inhibit")
- Liquid density and temperature in the density mode

Note Be sure to calibrate the balance after initialization.

- 1 Press the **ON:OFF** key to turn off the display.
- 2 While pressing and holding the **PRINT** key and the **RANGE** key, press the **ON:OFF** key to display **p5**.
- 3 Press the **RANGE** key to display **Clr**.
- 4 Press the **PRINT** key.
To cancel this operation, press the **CAL** key.
- 5 Press the **RE-ZERO** key to display **Clr go**.
- 6 Press the **PRINT** key to initialize the balance.
The balance will automatically return to the weighing mode.

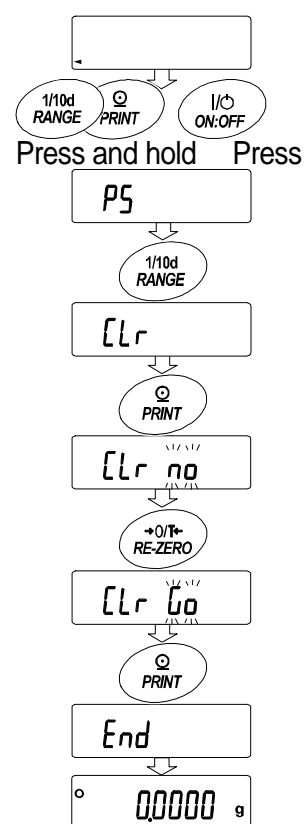

10. Function Table

This function table reads or rewrites the parameters that are stored in the balance. These parameters are maintained in non-volatile memory, even if the AC adapter is removed. This function table menu consists of two layers. The first layer is the "Class" and the second layer is the "Item".

- 1 Press and hold the **RANGE** key until **ba5fnc** of the function table is displayed in the weighing mode, then release the key
- 2 Press the **RANGE** key to select a class.
- 3 Press the **PRINT** key to enter the class
- 4 Press the **RANGE** key to select a item.
- 5 Press the **RE-ZERO** key to select a parameter of the selected item.
- 6 If storing parameters of the selected class, press the **PRINT** key. Then next class is displayed. If canceling the current operation, press the **CAL** key. Then next class is displayed.
- 7 When specifying parameters for other class, proceed to step 2. When finishing the setting, press the **CAL** key to return to weighing mode.

Example

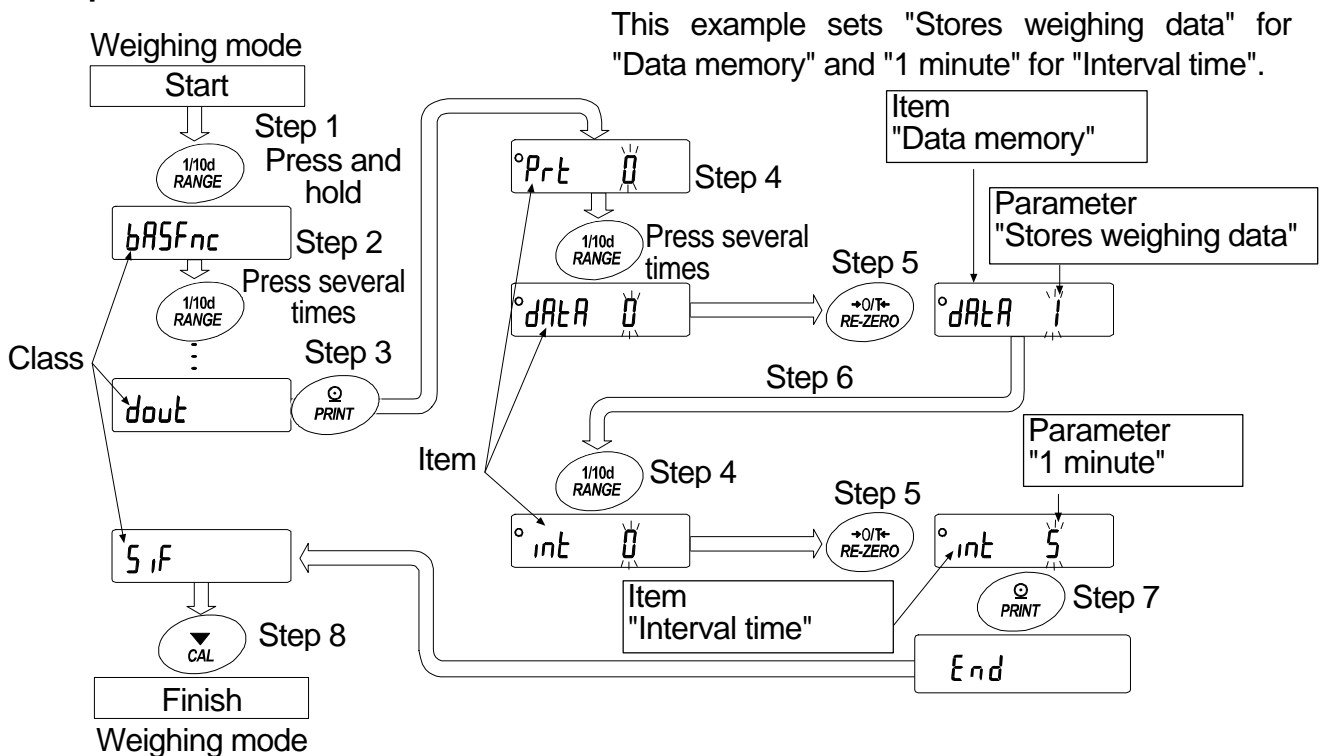

10.1. Details Of The Function Table

Class	Item and Parameter	Description		
ba5fnc Environment Display	Cond Condition	0	Fast response, sensitive value FAST	
		▪ 1	↕	
		2	Slow response, stable value SLOW	
	5t-b Stability band width	0	Stable range is ± 1 digit	#1
		▪ 1	↕	
		2	Stable range is ± 3 digits	
	trc Zero tracking	0	OFF	Keeps zero display by tracking zero drift.
		▪ 1	Normal	
		2	Middle	
		3	Strong	
5pd Display refresh rate	▪ 0	5 times/second	Period to refresh the display	
	1	10 times/second		
pnt Decimal point	▪ 0	Point (.)	Decimal point format	
	1	Comma (,)		
p-on Auto display-ON	▪ 0	OFF	Turns on the weighing mode display when the AC adapter is connected.	
	1	ON		
Cl adj Clock	Refer to "10.7. Clock and Calendar Function"		Confirms and sets the time and date. The time and date are added to the output data.	
dout Data output	prt Data output mode	▪ 0	Key mode	Accepts the PRINT key only when the display is stable.
		1	Auto print mode A (Reference = zero)	Outputs data when the display is stable and conditions of ap-p, ap-b and the reference value are met.
		2	Auto print mode B (Reference = last stable value)	
		3	Stream mode / Interval memory mode	With data 0, outputs data continuously; with data 2, uses interval memory.
	ap-p Auto print polarity	▪ 0	Plus only	Displayed value > Reference
		1	Minus only	Displayed value < Reference
		2	Both	Regardless of displayed value
	ap-b Auto print difference	0	10 digits	Difference between reference value and displayed value #2
		▪ 1	100 digits	
		2	1000 digits	
data Data memory	▪ 0	Not used	Related items: prt, i nt, d-no, 5-td, i nfo	
	1	Stores weighing data		
	2	Stores calibration data		

▪ : Factory settings.

#1 The unit of minimum display is digit.

Example: If 1 mg display is selected using the RANGE key for GH-300, 1 mg is one digit.

#2 Usable minimum display of the balance is one digit.

Example: In gram display, one digit is 0.00001 g for GH-252 and 0.0001 g for GH-300.

Class	Item and Parameter	Description		
dout Data output	i nt Interval time	▪ 0	Every measurement	Interval time in the interval memory mode when using prt 3, data 1
		1	2 seconds	
		2	5 seconds	
		3	10 seconds	
		4	30 seconds	
		5	1 minute	
		6	2 minute	
		7	5 minute	
	8	10 minute		
	d-no Data number output	▪ 0	No output	Refer to "12. Data Memory"
1	Output			
5-td Time/Date output	▪ 0	No output	Selects whether or not the time or date is added to the weighing data. Refer to "10.7. Clock and Calendar Function" for details.	
	1	Time only		
	2	Date only		
5-id ID number output	▪ 0	No output	Selects whether or not the ID number is output.	
	1	Output		
pU5e Data output pause	▪ 0	No pause	Selects the data output interval.	
1	Pause (1.6 seconds)			
at-f Auto feed	▪ 0	Not used	Selects whether or not automatic feed is performed.	
	1	Used		
i nfo GLP output	▪ 0	No output	Selects GLP output method. For how to set time and date to be added, refer to "10.7. Clock and Calendar Function".	
	1	AD-8121 format		
	2	General data format		
ar-d Zero after output	▪ 0	Not used	Adjusts zero automatically after data is output	
	1	Used		
5i f Serial interface	bp5 Baud rate	0	600 bps	
		1	1200 bps	
		▪ 2	2400 bps	
		3	4800 bps	
		4	9600 bps	
		5	19200 bps	
	btpr Data bit, parity bit	▪ 0	7 bits, even	
		1	7 bits, odd	
		2	8 bits, none	
	Cr l f Terminator	▪ 0	CR LF	CR: ASCII code 0Dh LF: ASCII code 0Ah
		1	CR	
	type Data format	▪ 0	A&D standard format	Refer to "10.5. Description of Item "Data Format".
		1	DP format	
2		KF format		
3		MT format		
4		NU format		
5	CSV format			

▪ : Factory settings.

Caution The balance may not transmit the data completely at the specified refresh rate, depending on the baud rate or data added to the weighing data such as time, date and ID number.





5i f Serial interface	t-Up Timeout	0	No limit	Selects the wait time to receive a command.
		▪ 1	1 second	
	erCd AK, Error code	0	No output	AK: ASCII code 06h
	1	Output		
Ct5 CTS, RTS control		0	Not used	Controls CTS and RTS.
		1	Used	
d5 fnc Density function	I di n Liquid density input	0	Water temperature	Available only when density mode is selected
		1	Liquid density	
Uni t Unit	Refer to "5. Weighing Units".			
C5 in ☆ Internal mass correction	Displayed only when the internal mass value correction switch is set to 1. Refer to "8. Calibration".			
i d ID number setting	Refer to "11. ID Number And GLP Report".			

▪ : Factory settings. Digit is a unit of minimum weighing value.

Caution

The balance may not transmit the data completely at the specified refresh rate, depending on the baud rate or data added to the weighing data such as time, date and ID number.

10.2. Display Symbol And Keys

	The symbol "O" shows effective parameter.
	When pressing and holding the key in the weighing mode, the mode enters the function table mode. The key to select the class or item in the function table mode.
	The key to change the parameter.
	When displaying a class, the key enters an item in the class. When displaying an item, the key stores the new parameter and displays the next class.
	When displaying an item, the key cancels the new parameter and displays the next class. When displaying a class, the key exits the function table mode and returns to the weighing mode.

10.3. Description Of The Class "Environment, Display"

Condition (Cond)

Cond 0 This parameter is for sensitive response to the fluctuation of a mass value. Used for powder target mass, weighing a very light sample or when quick response weighing is required. After setting, the balance displays **FAST**.



Cond 2 This parameter is for stable weighing with slow response. Used to prevent a mass value from drifting due to vibration or drafts. After setting, the balance displays **SLOW**.

Notes In automatic response adjustment, this parameter is selected automatically.

Stability band width (5t-b)

This item controls the width to regard a mass value as a stable value. When the fluctuation per second is less than the parameter, the balance displays the stabilization indicator and outputs or stores the data. The parameter influences the "Auto print mode"

5t-b 0 This parameter is used for sensitive response of the stabilization indicator. Used for exact weighing.



5t-b 2 This parameter ignores slight fluctuation of a mass value. Used to prevent a mass value from drifting due to vibration or drafts.

Zero tracking (trc)

This function tracks zero point drift caused by changes in the environment and stabilizes the zero point. When the weighing data is only a few digits, turn the function off for accurate weighing.

trc 0 The tracking function is not used. Used for weighing a very light sample.

trc 1 The normal tracking function is used.

trc 2 The middle tracking function is used.

trc 3 The strong tracking function is used. Used for stable zero display.

Display refresh rate (5pd)

Period to refresh the display. This parameter influences "Baud rate", "Data output pause" and "Stream mode".

Decimal point (pnt)

The decimal point format can be selected.

Auto display-ON (p-on)

When the AC adapter is plugged in, the display is automatically turned on without the **ON:OFF** key operation, to display the weighing mode. Used when the balance is built into an automated system. one hour warm up is necessary for accurate weighing.

10.4. Description Of The Item "Data Output Mode"

The parameter setting of "Data output mode (prt)" applies to the performance when the "Data memory (data)" parameter is set to "2" (to store the weighing data) and when the data is transmitted using the RS-232C interface.

Key mode

When the PRINT key is pressed with the stabilization indicator turned on, the balance outputs or stores the weighing data and the display blinks one time.

Required setting dout prt 0 Key mode

Auto print modes A and B

When the displayed value is stable and the conditions of "Auto print polarity", "Auto print difference" and reference value are met, the balance outputs or stores the weighing data.

When the PRINT key is pressed with the stabilization indicator turned on, the balance outputs or stores the data and the display blinks one time.

Auto print modes A

Example For weighing each time a sample is placed and removed, with "ar-d" set to "1" (to adjust zero after the data is output).

Required setting dout prt 1 Auto print mode A (reference = zero)
 dout ap-p Auto print polarity
 dout ap-b Auto print difference
 dout ar-d 1 Zero after output

Auto print modes B

Example For weighing while a sample is added.

Required setting dout prt 2 Auto print mode B (reference = last stable value)
 dout ap-p Auto print polarity
 dout ap-b Auto print difference

Stream mode

The balance outputs the weighing data continuously regardless of the display condition. The display does not blink in this mode. The interval memory mode is used when the "Data memory (data)" parameter is set to "1" (to store the weighing data).

Example For monitoring data on a computer.

Required setting dout prt 3 Stream mode
 dout data 0 Data memory function is not used
 ba5fnc 5pd Display refresh rate
 5i f bp5 Baud rate

Caution The balance may not transmit the data completely at the specified refresh rate, depending on the baud rate or data added to the weighing data such as time, date and ID number.

Interval memory mode

The weighing data is periodically stored in memory.

Example	For periodical weighing without a personal computer command and to output all of the data, to a computer, at one time.		
	The GH series can use time and date with "Time/Date output (5-td)".		
Required setting	dout prt 3	Interval memory mode	
	dout data 2	Data memory function is used	
	dout int	Interval time	
Optional setting	dout 5-td1, 2, or 3	Adds the time and date.	

10.5. Description Of The Item "Data Format"

A&D standard format

5if type 0

This format is used when the peripheral equipment can receive the A&D format.

If an AD-8121B is used, set the printer to MODE 1 or 2.

- This format consists of fifteen or sixteen characters excluding the terminator.
- When numerical characters without decimal point are exceeded eight characters for GH-252, the format becomes sixteen characters.
- A header of two characters indicates the balance condition.
- The polarity sign is placed before the data with the leading zeros. If the data is zero, the plus sign is applied.
- The unit, consisting of three characters, follows the data.

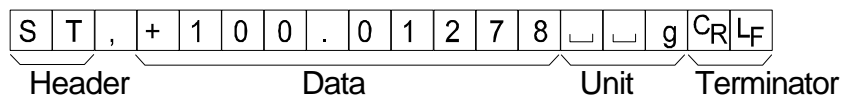
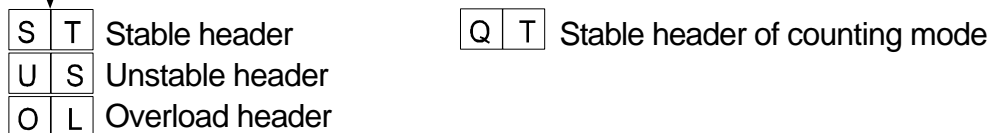
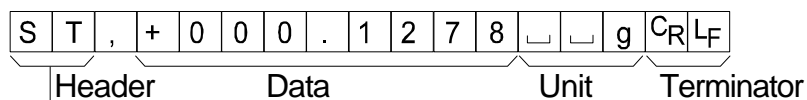

DP (Dump print) format

5if type 1

This format is used when the peripheral equipment can not receive the A&D format.

If an AD-8121B is used, set the printer to MODE 3.

- This format consists of sixteen characters excluding the terminator.
- A header of two characters indicates the balance condition. No overload header is used.
- The polarity sign is placed before the data, with spaces in place of leading zeros, if the data is not zero or overloaded.
- The unit, consisting of three characters, follows the data.

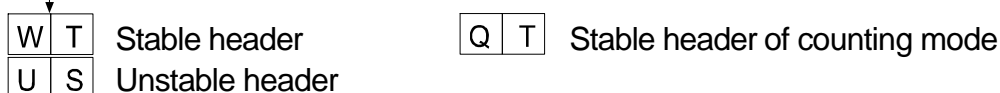
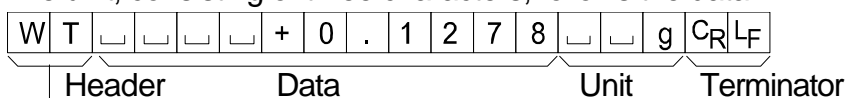

KF format

5i f type 2

This is the Karl-Fischer moisture meter format and is used when the peripheral equipment can only communicate using this format.

- This format consists of fifteen characters excluding the terminator.
- This format has no header characters.
- The polarity sign is placed before the data, with spaces in place of leading zeros, if the data is not zero or overloaded.
- This format outputs the unit only for a stable value.

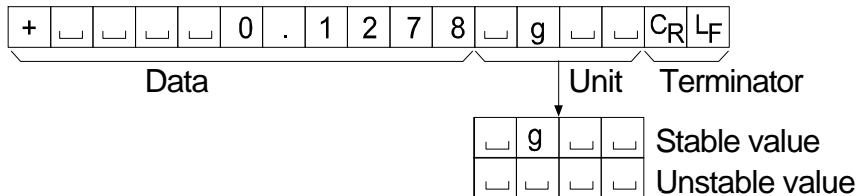

MT format

5i f type 3

- A header of two characters indicates the balance condition.
- The polarity sign is used only for negative data.
- The weighing data uses spaces in place of the leading zeros.
- The character length of this format changes dependent upon the unit

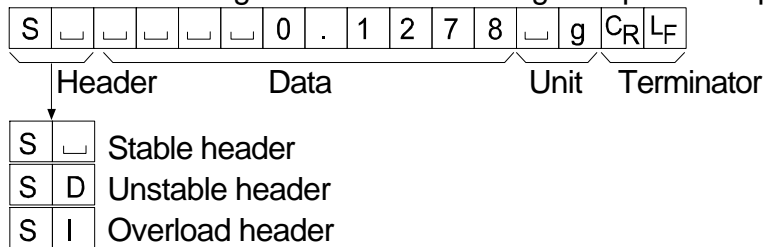

NU (numerical) format

5i f type 4

This format outputs only numerical data.

- This format consists of ten characters excluding the terminator.
- The polarity sign is placed before the data with the leading zeros. If the data is zero, the plus sign is used.

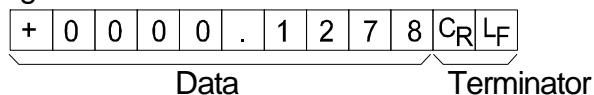

CSV format

5i f type 5

- This format separates the data of A&D standard format and the unit by a comma (,).
- This format outputs the unit even when the data is overloaded.
- When a comma (,) is selected for decimal point, separators are set to semicolon (;).
- When the ID number, data number, time and date are added at "Data output (dout)" of the function table, outputs ID number, data number, date, time and weighing data in this order and separates each item by a comma and treats all the items as one group of data.

LAB-123, No,012, 2004/07/01, 12:34:56, ST,+0000.1278,□□g<CR><LF>

ID number
Data number
Date
Time
Weighing data

S	T	,	+	0	0	0	.	1	2	7	8	,	□	□	g	C _R	L _F
---	---	---	---	---	---	---	---	---	---	---	---	---	---	---	---	----------------	----------------

O	L	,	+	9	9	9	9	9	9	E	+	1	9	,	□	□	g	C _R	L _F
---	---	---	---	---	---	---	---	---	---	---	---	---	---	---	---	---	---	----------------	----------------

ID number

dout 5-id 1

The number to identify a specific balance.

- This format consists of seven characters excluding the terminator.

L	A	B	-	0	1	2	3	C _R	L _F
---	---	---	---	---	---	---	---	----------------	----------------

Data number

dout d-no 1

This format outputs the data number just before the data is transmitted using the RS-232C interface.

- This format consists of six characters excluding the terminator.
- When CSV format (5i f type 5) is selected, the period (.) is replaced with a comma (,).

N	o	,	0	0	1	C _R	L _F
---	---	---	---	---	---	----------------	----------------

Data number
Terminator

Date

dout 5-td 2 or 3

- The date output order can be changed in " Time/Date output (5-td)" and "Clock (Cl adj)".
The year is output in a four-digit format.

2	0	0	4	/	0	7	/	0	1	C _R	L _F
---	---	---	---	---	---	---	---	---	---	----------------	----------------

Time

dout 5-td 1 or 3

- This format outputs time in 24-hour format.

1	2	:	3	4	:	5	6	C _R	L _F
---	---	---	---	---	---	---	---	----------------	----------------

10.6. Data Format Examples

Stable

° 0.1278 g

A&D	S	T	,	+	0	0	0	.	1	2	7	8	␣	␣	g	C _R	L _F		
DP	W	T	␣	␣	␣	␣	␣	+	0	.	1	2	7	8	␣	␣	g	C _R	L _F
KF	+	␣	␣	␣	␣	0	.	1	2	7	8	␣	g	␣	␣	C _R	L _F		
MT	S	␣	␣	␣	␣	␣	0	.	1	2	7	8	␣	g	C _R	L _F			
NU	+	0	0	0	0	.	1	2	7	8	C _R	L _F							

Unstable

° 18.3690 g

A&D	U	S	,	-	0	1	8	.	3	6	9	0	␣	␣	g	C _R	L _F		
DP	U	S	␣	␣	␣	␣	-	1	8	.	3	6	9	0	␣	␣	g	C _R	L _F
KF	-	␣	␣	␣	1	8	.	3	6	9	0	␣	␣	␣	␣	C _R	L _F		
MT	S	D	␣	␣	-	1	8	.	3	6	9	0	␣	g	C _R	L _F			
NU	-	0	0	1	8	.	3	6	9	0	C _R	L _F							

Overload

Positive error

E g

A&D	O	L	,	+	9	9	9	9	9	9	9	E	+	1	9	C _R	L _F
DP	␣	␣	␣	␣	␣	␣	␣	␣	E	␣	␣	␣	␣	␣	␣	C _R	L _F
KF	␣	␣	␣	␣	␣	␣	H	␣	␣	␣	␣	␣	␣	␣	␣	C _R	L _F
MT	S	I	+	C _R	L _F												
NU	+	9	9	9	9	9	9	9	9	9	C _R	L _F					

Overload

Negative error

-E g

A&D	O	L	,	-	9	9	9	9	9	9	9	E	+	1	9	C _R	L _F
DP	␣	␣	␣	␣	␣	␣	␣	-	E	␣	␣	␣	␣	␣	␣	C _R	L _F
KF	␣	␣	␣	␣	␣	␣	L	␣	␣	␣	␣	␣	␣	␣	␣	C _R	L _F
MT	S	I	-	C _R	L _F												
NU	-	9	9	9	9	9	9	9	9	9	C _R	L _F					

␣ Space, ASCII 20h
 C_R Carriage Return, ASCII 0Dh
 L_F Line Feed, ASCII 0Ah

Units

		A&D	D.P.	KF	MT
g	g	□ □ g	□ □ g	□ g □ □	□ g
mg	mg	□ m g	□ m g	□ m g □	□ m g
Counting mode	pcs	□ P C	□ P C	□ p c s	□ P C S
Precent mode	%	□ □ %	□ □ %	□ % □ □	□ %
Ounce (Avoir)	oz	□ o z	□ o z	□ o z □	□ o z
Troy Ounce	ozt	o z t	o z t	□ o z t	□ o z t
Metric Carat	ct	□ c t	□ c t	□ c t □	□ c t
Momme	mom	m o m	m o m	□ m o m	□ m o
Pennyweight	dwt	d w t	d w t	□ d w t	□ d w t
Grain	GN	□ G N	□ G N	□ g r □	□ G N
Tael (HK general, Singapore)	tl	□ t l	□ t l	□ t l s	□ t l
Tael (HK, jewelry)	tl	□ t l	□ t l	□ t l h	□ t l
Tael (Taiwan)	tl	□ t l	□ t l	□ t l t	□ t l
Tael (China)	tl	□ t l	□ t l	□ t l c	□ t l
Tola (India)	t	□ □ t	□ □ t	□ t o l	□ t
Messghal	m	m e s	m e s	□ M S □	□ m
Density		□ D S	□ D S	□ D S □	□ D S

□ Space, ASCII 20h

10.7. Clock And Calendar Function

The balance is equipped with a clock and calendar function. When the "GLP output (info)" parameter is set to "1" or "2" and the "Time/Date output (5-td)" parameter is set to "1", "2" or "3", the time and date are added to the output data. Set or confirm the time and date as follows:

Operation

- 1 Press and hold the **RANGE** key until **ba5fnc** of the function table is displayed in the weighing mode, then release the key.
- 2 Press the **RANGE** key several times to display **Cl adj**.
- 3 Press the **PRINT** key.
The balance enters the mode to confirm or set the time and date.

Confirming the time

- 4 The current time is displayed with all the digits blinking.
 - When the time is correct and the date does not need to be confirmed, press the **CAL** key and proceed to step 8.
 - When the time is correct and the date is to be confirmed, press the **RANGE** key and proceed to step 6.
 - When the time is not correct and is to be changed, press the **RE-ZERO** key and proceed to step 5.

Setting the time

- 5 Set the time in 24-hour format using the following keys.
 - RANGE** key..... The key to select the digits to change the value.
The selected digits blink.
 - RE-ZERO**(-)key.... The key to increase the value by one.
 - MODE**(+)key The key to decrease the value by one.
 - PRINT** key..... The key to store the new setting, display **end** and proceed to step 6.
 - CAL** key..... The key to cancel the new setting and proceed to step 6.

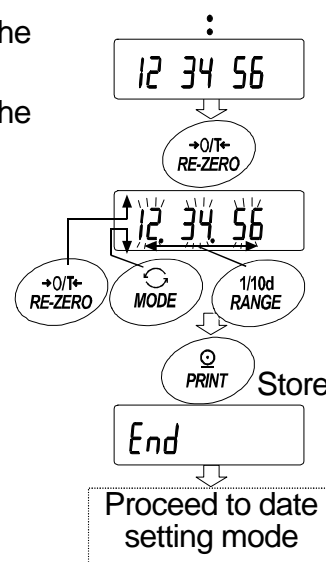

Confirming the date

- 6 The current date is displayed with all the digits blinking.
 - To change the display order of year (y), month (m) and day (d), press the **MODE** key. The date is outputted in the order as specified.
 - When the date is correct and the operation is to be finished, press the **CAL** key and proceed to step 8.
 - When the time is to be confirmed again, press the **RANGE** key and proceed back to step 4.
 - When the date is not correct and is to be changed, press the **RE-ZERO** key and proceed to step 7.

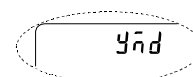

Note The year is expressed using a two-digit format.
For example: The year 2004 is expressed as "04".

Setting the date

7 Set the date using the following keys.

RANGE key The key to select the digits to change the value.
The selected digits blink.

RE-ZERO key The key to increase the value by one.

MODE key The key to decrease the value by one.

PRINT key The key to store the new setting, display
end and proceed to step 8.

CAL key The key to cancel the new setting and
proceed to step 8.

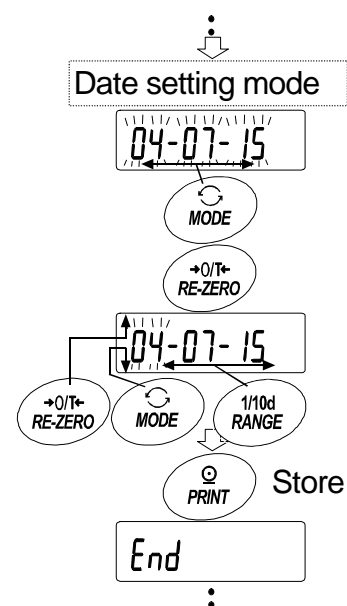

Quitting the operation

8 The balance displays the next menu item of the function table.

Press the **CAL** key to exit the clock and calendar function and return to the weighing mode.

Note Do not enter invalid values such as a non-existing date when setting the time and date.

When the clock backup battery has been depleted, the balance displays **rtc pf**. Under this condition, press any key and set the time and date. The dead battery only affects the clock and calendar function. Even so, the function works normally as long as the AC adapter is connected to the balance.

11. ID Number And GLP Report

- The ID number is used to identify the balance when Good Laboratory Practice (GLP) is used.
- The ID number is maintained in non-volatile memory even if the AC adapter is removed.
- The GLP output format is selected at "GLP output (info)" of the function table and can be output to a personal computer or printer using the RS-232C serial interface.
- The GLP output format includes the balance manufacturer, model, serial number, ID number, date, time and space for signature for weighing data, the weight used and results for calibration or calibration test data.
- The balance can output the following reports for GLP.
 - "Calibration report" of the calibration, using the internal mass (Calibration due to changes in temperature and one-touch calibration.)
 - "Calibration report" of the calibration, using an external weight.
 - "Calibration test report" of the calibration test, using an external weight.
 - "Title block" and "End block" for the weighing data.
- Calibration and calibration test data can be stored in memory to output several reports at the same time. Refer to "12. Data Memory" for details.
- For details on confirming and setting the time and date for the GH series. Refer to "10.7. Clock and Calendar Function".

11.1. Setting The ID Number

- 1 Press and hold the **RANGE** key until **ba5fnc** of the function table is displayed, then release the key.
- 2 Press the **RANGE** key several times to display **i d**.
- 3 Press the **PRINT** key. Set the ID number using the following keys.
 - RE-ZERO** key..... The key to set the character of the digit selected.
Refer to the display character set shown below.
 - RANGE** key..... The key to select the digit to change the value.
 - PRINT** key..... The key to store the new ID number and display **ba5fnc**.
 - CAL** key..... The key to cancel the new ID number and display **ba5fnc**.
- 4 With **ba5fnc** displayed, press the **CAL** key to return to the weighing mode.

0	1	2	3	4	5	6	7	8	9	-	␣	A	B	C	D	E	F	G	H	I	J	K	L	M	N	O	P	Q	R	S	T	U	V	W	X	Y	Z
0	1	2	3	4	5	6	7	8	9	-	␣	A	b	[d	E	F	G	H	I	J	K	L	M	N	O	P	Q	R	S	T	U	V	W	X	Y	Z

␣ Space

11.2. GLP Report

Set the following parameters to output the report.

- Refer to "15.2. Connection to peripheral equipment" for the connection of the AD-8121B.
- To print the report, set the "GLP output (i nfo)" parameter to "1" and use MODE 3 of the AD-8121B. If MODE1 is used, select temporary dump print mode by pressing the **[STAT.]** key of the AD-8121B.
- To output the report to a personal computer using the RS-232C interface, set the "GLP output (i nfo)" parameter to "2".
- If the time and date are not correct set the correct time and date in "Clock (Cl adj)" of the function table.

Calibration report using the internal mass

Key operation

- 1 Press the **[CAL]** key to display **[Cal i n]** and calibrate the balance automatically.
- 2 If GLP output is used, **[glp]** is displayed and the calibration report is outputted.
- 3 The balance returns to weighing mode after this calibration.

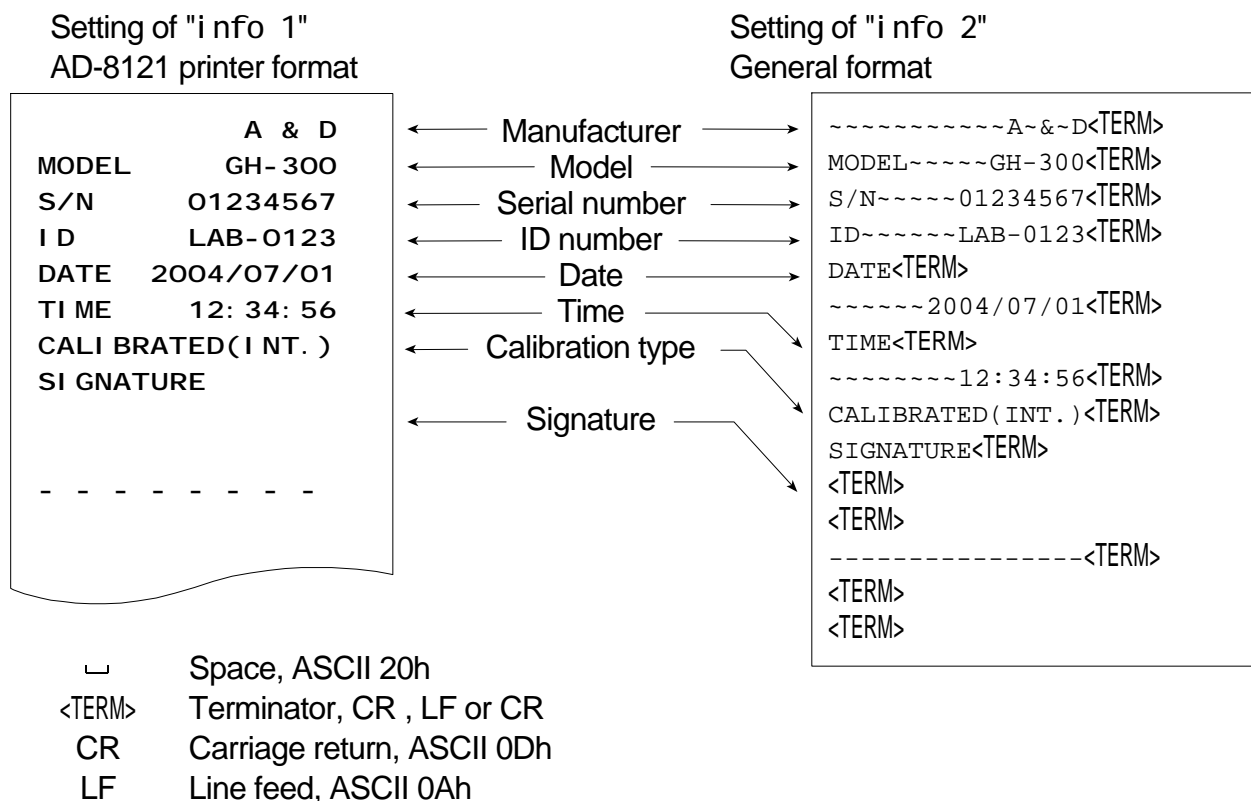

Calibration test report using an internal mass

Note Calibration test does not perform calibration.

Key operation

- 1 Press and hold the `[CAL]` key to display `[CC i n]` and release the key.
- 2 `[CC]` is displayed and the balance is tested automatically.
- 3 Zero point is weighed and the weighing value is displayed for few seconds.
- 4 Internal mass is weighed and the weighing value is displayed for few seconds.
- 5 If GLP output is used, `[glp]` is displayed and the calibration test report is outputted.
- 6 The balance returns to weighing mode after this test.

Commad

This calibration test report can be performed with commad TST.

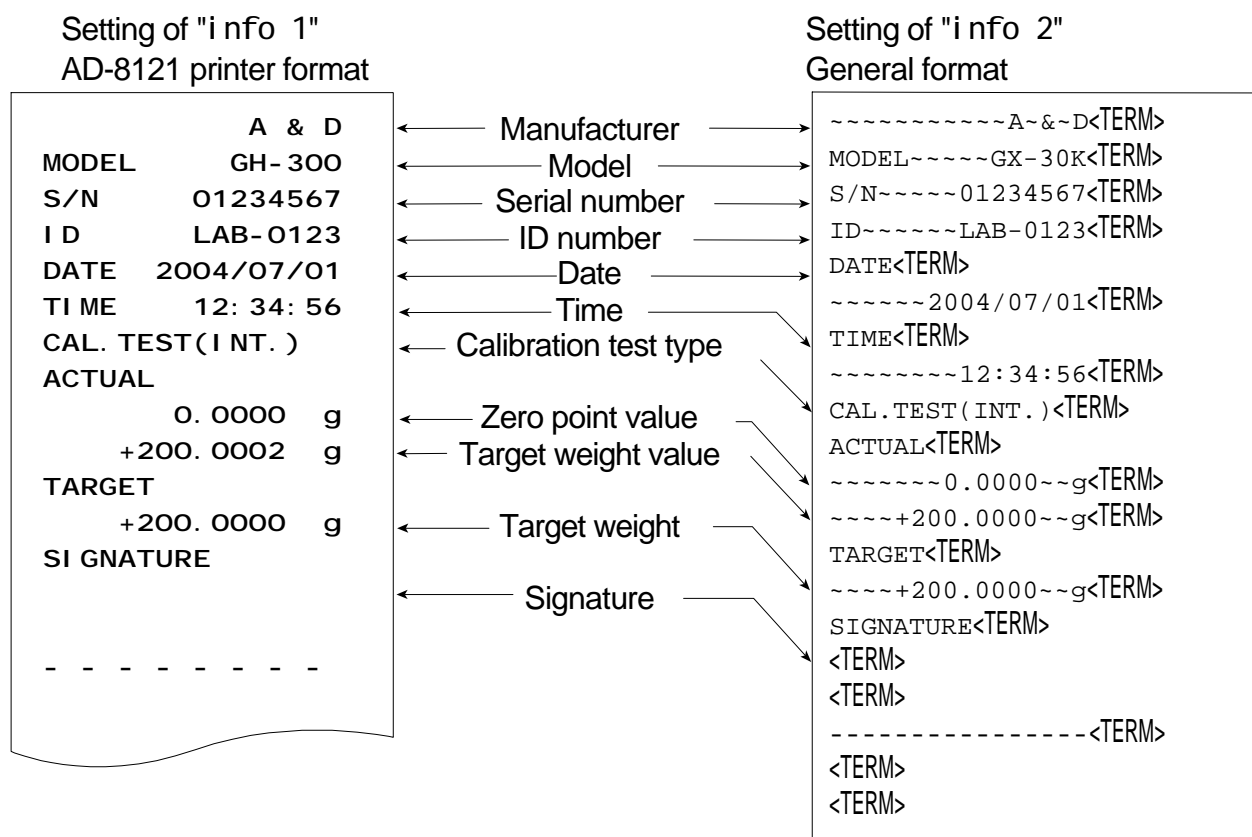

- ␣ Space, ASCII 20h
- <TERM> Terminator, CR , LF or CR
- CR Carriage return, ASCII 0Dh
- LF Line feed, ASCII 0Ah

Calibration report using an external weight

Key operation

- 1 Press and hold the **CAL** key to display **Cal out** and release the key.
- 2 **Cal 0** is displayed.
- 3 When updating the calibration mass value, press the **RANGE** key and proceed to step 4.
When using preset calibration mass value, proceed to step 5.
- 4 Specify calibration mass value using the following keys.
RANGE key The key to select the blinking figure
RE-ZERO(+)key .. The key to increase the value of the blinking figure.
MODE(-)key The key to decrease the value of the blinking figure.
PRINT key The key to store the new value.
- 5 When pressing the **RE-ZERO** key, zero point is weighed and the weighing value is displayed for few seconds.
- 6 Put displayed mass on the pan. Press the **PRINT** key to weigh the mass and the weighing value is displayed for few seconds.
- 7 If GLP output is used, **glp** is displayed and the calibration report is outputted.
- 8 The balance returns to weighing mode after this calibration.

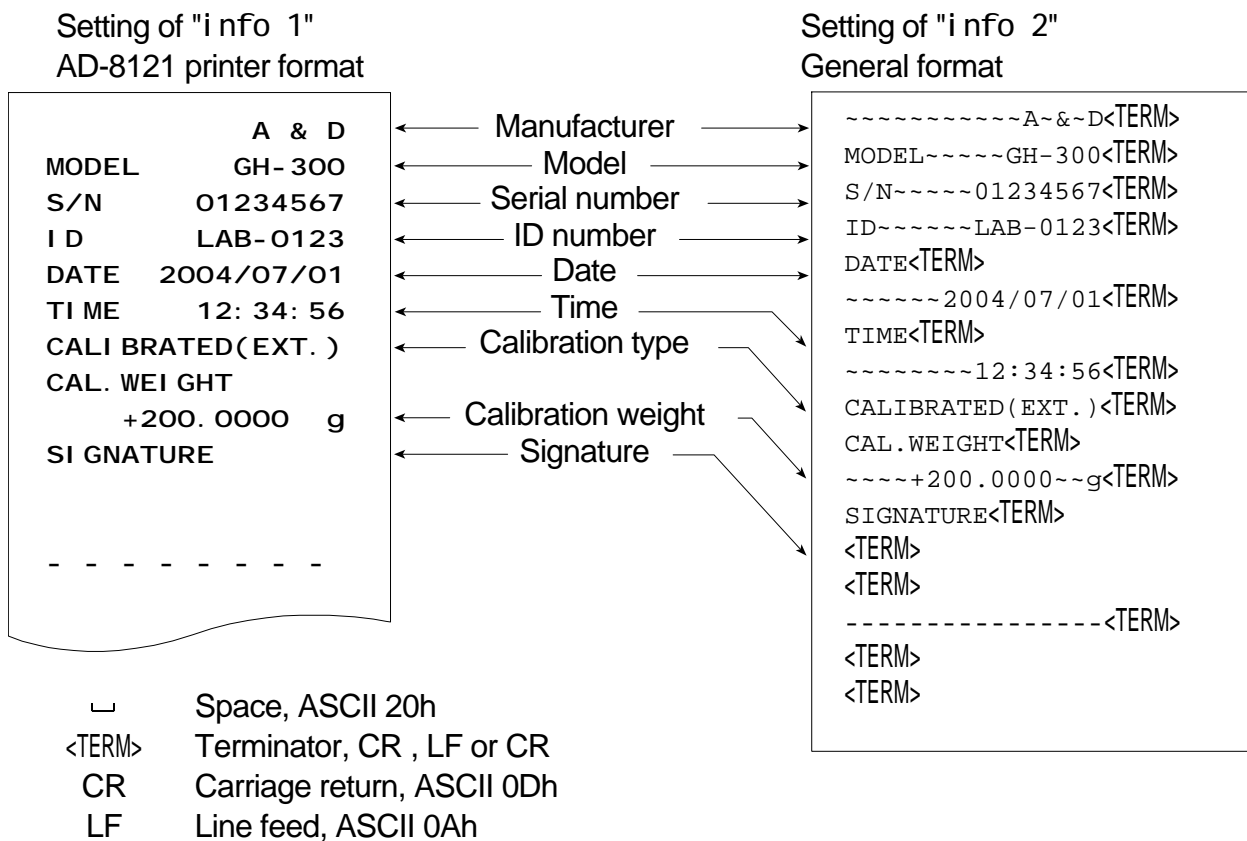

Calibration test report using an external weight

Note Calibration test does not perform calibration.

Key operation

- 1 Press and hold the **[CAL]** key to display **[CC out]** and release the key.
- 2 **[Cal 0]** is displayed.
- 3 When updating the target value, press the **[RANGE]** key and proceed to step 4.
When using preset target value, proceed to step 5.
- 4 Specify calibration mass value using the following keys.
[RANGE] key The key to select the blinking figure
[RE-ZERO](+)key .. The key to increase the value of the blinking figure.
[MODE](-)key The key to decrease the value of the blinking figure.
[PRINT] key The key to store the new value.
- 5 When pressing the **[RE-ZERO]** key, zero point is weighed and the weighing value is displayed for few seconds.
- 6 Put displayed mass on the pan. Press the **[PRINT]** key to weigh the mass and the weighing value is displayed for few seconds.
- 7 If GLP output is used, **[glp]** is displayed and the calibration test report is outputted.
- 8 The balance returns to weighing mode after this test.

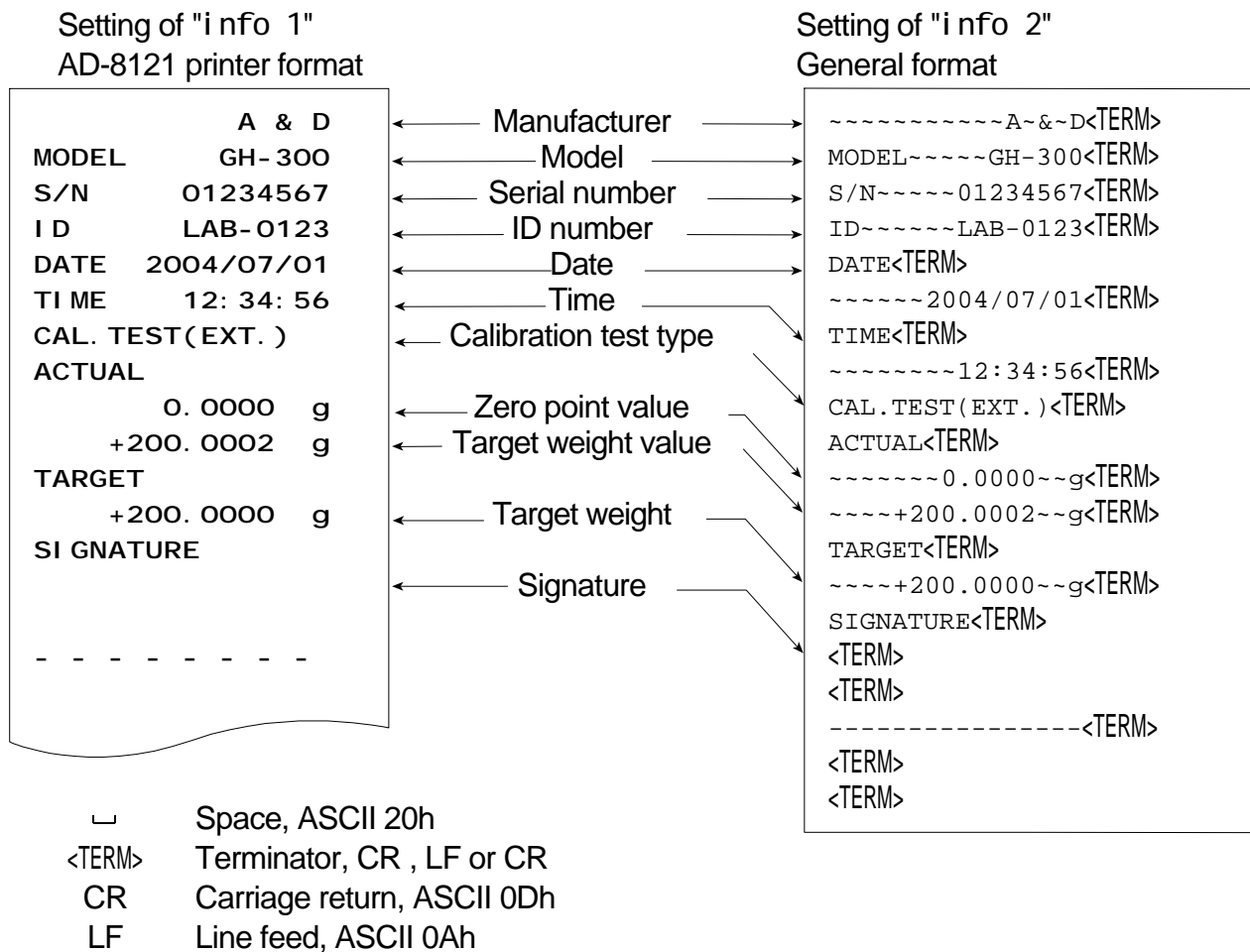

Title block and end block

When mass values are recorded as GLP data, a "Title block" is inserted at the beginning and an "End block" is inserted at the end of a group of mass values in the GLP report.

Notes

- To output the report to an AD-8121B, use MODE 3 of the AD-8121B. If MODE1 is used, select temporary dump print mode by pressing the **STAT** key of the AD-8121B.
- If the data memory function is used (except data 0), the "Title block" and "End block" can not be output.

Key operation

- 1 With the weighing data displayed, press and hold the **PRINT** key, then release the key. **5start** is displayed. The "Title block" is output.
- 2 The weighing data is output according to the parameter setting of the data output mode (prt) of the function table.
- 3 Press and hold the **PRINT** key until **recend** is displayed, then release the key. The "End block" is output.

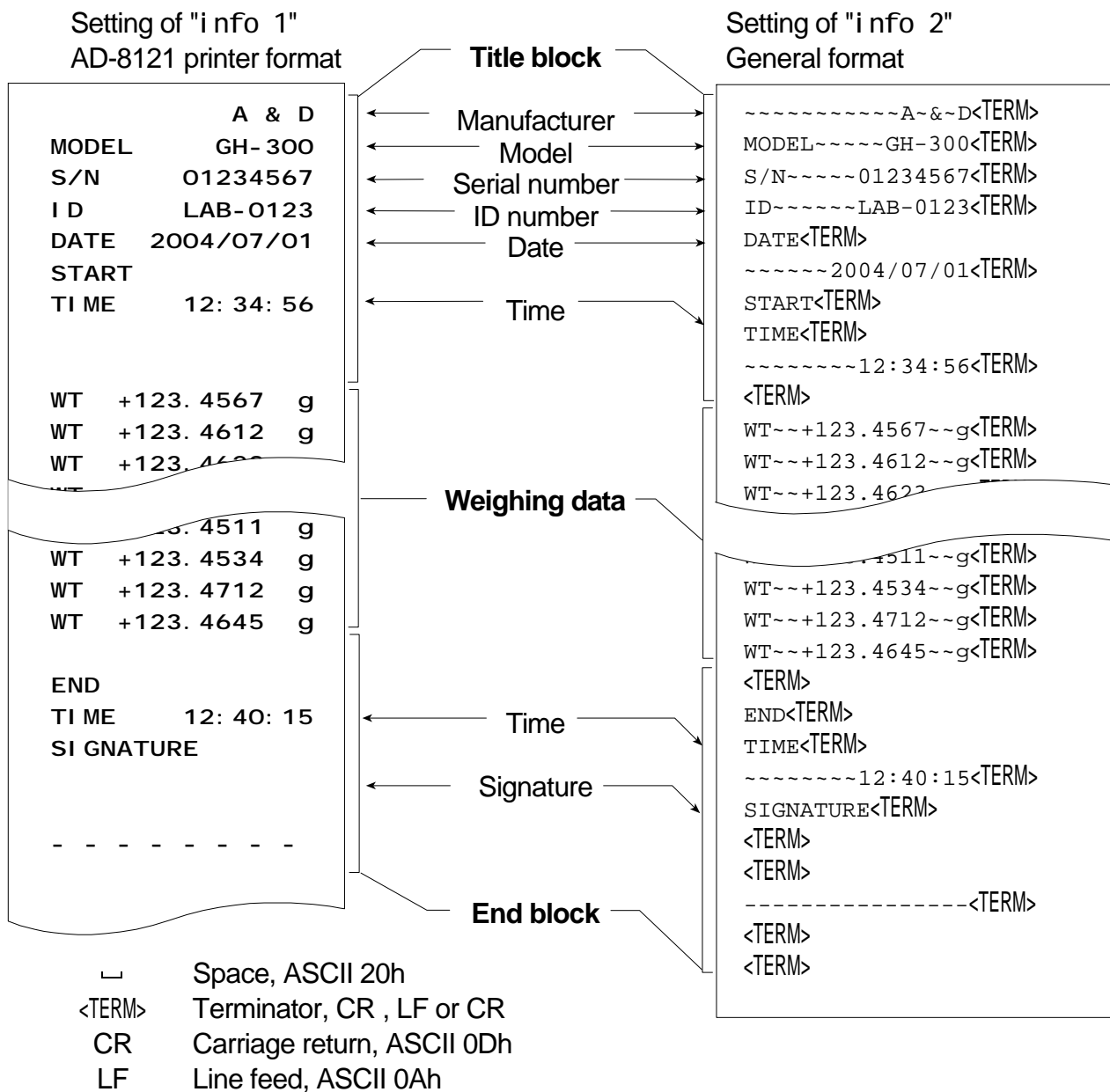

12. Data Memory

Data memory is a function to store weighing data and calibration data in memory. The data stored in memory are available for outputting at one time to a printer or personal computer.

Weighing data	Excluding date and time	Up to 200 sets
	Including date and time	Up to 100 sets
Calibration report Internal calibration External calibration Calibration test report Internal test calibration External test calibration		Last 50 sets

12.1. Notes on Using Data Memory

- To use the memory function, set the "Data memory (data)" parameter and "Time/Date output (5-td)" parameter of the function table. Refer to "10. The Function Table" for details on setting the data memory.
- For weighing data, the data contents to be stored and the storage capacity depend on the "Time/Date output (5-td)" parameter setting.
- If a different type of data exists in memory, "Cl r" blinks the upper left of the display. For example, you want to store weighing data but calibration data or unit mass data remains in memory. Under such a condition, before storing data, delete the data in memory as follows:

Upper left of the display

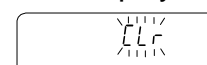

Releasing "Cl r" or "err"

- 1 Press and hold the **PRINT** key until **SCI r hb** with "no" blinking is displayed, then release the key.
- 2 Press the **RE-ZERO** key to display **SCI r gb** with "go" blinking. The type of data stored in memory appears in the upper left of the display as shown below:

Weighing data without time and date	-d-
Weighing data with time and date	d-t
Calibration report	Hi 5

- 3 Press the **PRINT** key to delete all the data in memory.
- 4 The balance displays **end** and returns to the weighing mode.

12.2. Data Memory for Weighing Data

- The balance can store 200 sets of weighing data in memory (if time and date are added, the balance can store 100 sets). Even if the AC adapter is removed, the data is maintained in non-volatile memory.
- It is not necessary to connect the printer or personal computer to the balance continually, because the balance stores the weighing data in memory.
- The data in memory can be outputted at one time to a printer or personal computer.
- The data in memory can be displayed on the balance for confirmation.
- Data (ID number, data number, time and date) to be added to the output data can be selected in the function setting.

Storing the weighing data

Note If "Clr" blinks in the upper left of the display, delete the data in memory.

- 1 Set the "Data memory (data)" parameter to "1".
- 2 Specify the "Time/Date output (5-td)" parameter whether time and date is to added or not.
- 3 The storing mode depends on the "Data output mode (prt)" parameter setting. Four types of storing modes are available to store data.

Key modeWhen the key is pressed and the displayed value is stable, the balance stores the weighing data.

Auto print modes AWhen the displayed value is stable and the conditions of "Auto print polarity", "Auto print difference" and zero point (reference value) are met, the balance stores the weighing data.

Auto print modes BWhen the displayed value is stable and the conditions of "Auto print polarity", "Auto print difference" and last stable data (reference value) are met, the balance stores the weighing data.

Interval memory mode.....Weighing data is stored at an interval specified in "Interval time (int)". Press the key to start and stop this mode.

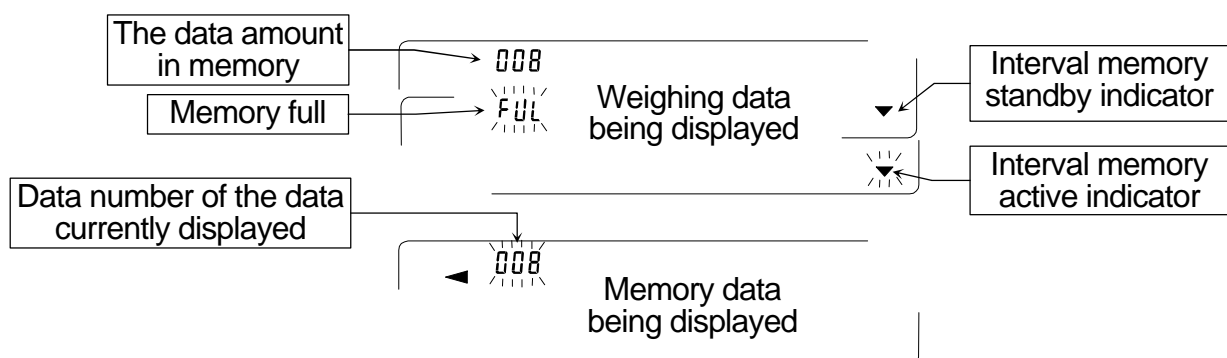

Caution

- When weighing data is being stored in memory, the data can not be output to a personal computer using the RS-232C interface.
- "FUL" indicates that memory is full or the memory capacity has been reached. More data can not be stored unless the memory data is deleted.

- Automatic self calibration can not be used while the interval memory mode is active.
- The following commands can not be used during data storage.
 - Q Query command for weighing data.
 - S Query command for stable weighing data.
 - SI Query command for weighing data.
 - SIR Query command for continuous weighing data.

Setting the function table

Parameter settings for each output mode are as follows:

Mode \ Item	Data output mode	Auto print polarity, difference	Data memory function	Interval time
Key mode	prt 0	Not used	data 1	Not used
Auto print mode A	prt 1	ap-a 0-2	data 1	
Auto print mode B	prt 2	ap-b 0-2	data 1	
Interval memory mode	prt 3	Not used	data 1	int 0-8

Additional parameter settings, as follows:

Data number	No	d-no 0	Time and date	No	5-td 0
	Yes	d-no 1		Time only	5-td 1
ID number	No	5-i d 0		Date only	5-td 2
	Yes	5-i d 1		Both	5-td 3

Enabling the data memory function

- 1 Press and hold the **RANGE** key until **ba5fnc** is displayed, then release the key.
- 2 Press the **RANGE** key several times to display **dout**.
- 3 Press the **PRINT** key.
- 4 Press the **RANGE** key three times to display **data 0**.
- 5 Press the **RE-ZERO** key to display **data 1**.
- 6 Press the **PRINT** key to store the setting.
- 7 Press the **CAL** key to return to the weighing mode.

Recalling the memory data

Confirm that the "Data memory (data)" parameter is set to "2".

- 1 Press and hold the **PRINT** key until **reCall** is displayed, then release the key.
- 2 Press the **PRINT** key to enter the memory recall mode. The type of data appears in the upper left of the display as shown to the right. Recall the data in memory using the following keys.
RE-ZERO key..... To proceed to the next data set.
MODE key..... To go back to the previous data set.
PRINT key..... To transmit the current data using the RS-232C interface.
With **RANGE** held down, press the **CAL** key
To delete the current data.
CAL key..... To exit the memory recall mode.
- 3 Press the **CAL** key to return to the weighing mode.

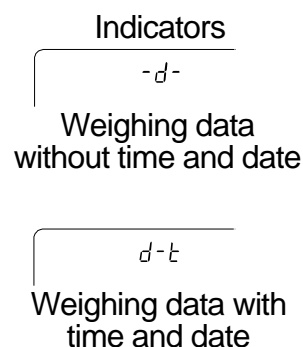

Transmitting all memory data at one time

Confirm that the "Serial interface (5i f)" parameters are set properly.

Refer to "10. Function Table" and "15.2. Connection To Peripheral Equipment".

- 1 Press and hold the **PRINT** key until **reCall** is displayed, then release the key.
- 2 Press the **RANGE** key to display **out**.
- 3 Press the **PRINT** key to display **out hb** with "no" blinking.
- 5 Press the **RE-ZERO** key to display **out gb** with "go" blinking.
- 6 Press the **PRINT** key to transmit all data using the RS-232C interface.
- 7 The balance displays **Clear** when all data is transmitted.
Press the **CAL** key to return to the weighing mode.

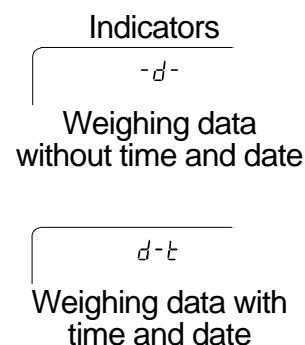

Deleting all memory data at one time

- 1 Press and hold the **PRINT** key until **reCall** is displayed, then release the key.
- 2 Press the **RANGE** key several times to display **Clear**.
- 3 Press the **PRINT** key to display **Cl r hb** with "no" blinking.
- 4 Press the **RE-ZERO** key to display **Cl r gb** with "go" blinking.
- 5 Press the **PRINT** key to delete all data
- 6 The balance displays **end** when all data is deleted. The balance displays **reCall** .
- 7 Press the **CAL** key to return to the weighing mode.

12.3. Data Memory for Calibration and Calibration Test

- Calibration data (when and how it is performed) and calibration test data can be stored in memory.
- All the data in memory is available to be output at one time to a printer or personal computer.
- Up to 50 data sets of the latest calibration or calibration test can be stored. When the memory capacity has been reached, "FUL" illuminates in the upper left of the display as shown below.

Indicator



FUL

Storing the calibration and calibration test data

Note If "Cl r" appears blinking in the upper left of the display, delete the data in memory.

Store the calibration and calibration test data as follows:

- 1 Set the "Data memory (data)" parameter to "2".
- 2 Set the "GLP output (i nfo)" parameter to "1" or "2".
- 3 With the settings above, each time calibration or calibration test is performed, the data is stored automatically.

Transmitting the memory data

Note

- Confirm that the "Serial interface (5i f)" parameters are set properly. Refer to "10. Function Table" and "15.2. Connection To Peripheral Equipment".
- Confirm that the "Data memory (data)" parameter is set to "2".

- 1 Press and hold the **PRINT** key until **out** is displayed, then release the key.
- 2 Press the **PRINT** key to display **out hb** with "no" blinking.
- 3 Press the **RE-ZERO** key to display **out gb** with "go" blinking.
- 4 Press the **PRINT** key to transmit all memory data using the RS-232C interface.
- 5 The balance displays **Clear** when all memory data is output. Press the **CAL** key to return to the weighing mode.

In the upper left of the display



H 15

Deleting data stored in memory

- 1 Press and hold the **PRINT** key until **out** is displayed, then release the key.
- 2 Press the **SAMPLE** key to display **Clear**.
- 3 Press the **PRINT** key to display **Cl r hb** with "no" blinking.
- 4 Press the **RE-ZERO** key to display **Cl r gb** with "go" blinking.
- 5 Press the **PRINT** key to delete all data.
- 6 The balance displays **out** when all the data has been deleted. Press the **CAL** key to return to the weighing mode.

In the upper left of the display



H 15

13. Underhook

The underhook can be used for magnetic materials or density measurement. The built-in underhook is revealed by removing the cover plates on the bottom of the balance. Use the underhook as shown below.

Caution

- Do not apply excessive force to the underhook.
- When not in use, attach the cover plate to prevent dust from getting into the balance.
- Do not push the underhook upward
- When turning over the balance, the weighing pan, pan support breeze breaking and dust plate fall off. Remove them first.
- While removing the cover, weighing error may occur, because draft breezes into the internal balance. Arrange the room condition.

- 1 Remove the cover on the bottom of the balance.
- 2 Hang your weighing pan to the underhook.
Place the balance on the film table.

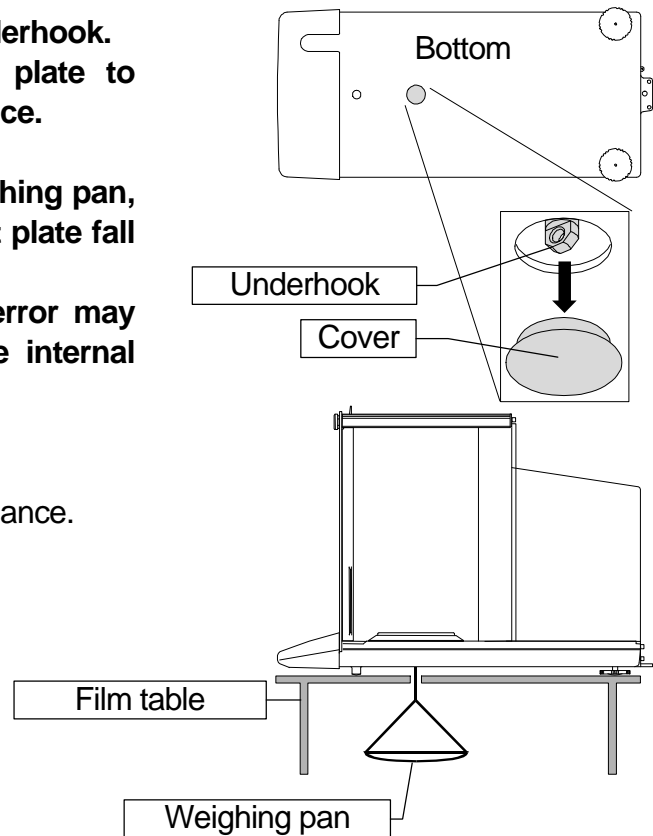

14. Density Measurement

The balance is equipped with a density mode. It calculates the density of a solid using the mass value of a sample in air and the mass value in liquid.

Note

- The density mode was not selected for use when the balance was shipped from the factory. To use the mode, change the function table and activate the density mode.
- When the density mode is selected, the response adjustment function can not be used.
- Minimum display is 0.0001 g while density mode.

Formula to obtain the density

The density can be obtained by the following formula.

$$\rho = \frac{A}{A - B} \times \rho_0$$

Where

- ρ : Density of a sample
- A : Mass value of a sample in air
- B : Mass value of a sample in liquid
- ρ_0 : Density of a liquid

Prior to measurement: Changing the function table

Prior to measurement, change the function table as follows:

- 1 Selecting the density mode.
The density mode is available as one of the weighing units. Select it by pressing the **[MODE]** key. To use the mode, select it (unit of **[Unit d]**.) in the function table. Refer to "5.2. Changing Units".
- 2 Selecting a way to set the density of a liquid.
Select the liquid density input method from the function table below.

Note

The function table is available only when the density mode (d5fnc) is selected. d5fnc is displayed next 5i f when density mode is active at Uni t.

Class	Item and Parameter	Description
d5 fnc Density function	I di n Liquid density input	▪ 0 Water temperature
		▪ 1 Liquid density

▪ is factory setting.

Entering the density of a liquid

Two ways to set the density of a liquid are available in the function table, "Liquid density input (I di n): by entering the water temperature or by entering the density directly.

- 1 Press the **MODE** key as necessary to select the density mode. When the density mode begins, "g (gram)" is displayed and the processing indicator (◀) blinks.



Entering the water temperature (I di n 0)

- 2 The water temperature currently set (unit: °C, factory setting : 25°C) is displayed. Use the following keys to change the value.



RE-ZERO(+)key .. The key to increase the temperature by one degree.
(0°C is displayed after 99°C)

MODE(-)key The key to decrease the temperature by one degree.
(99°C is displayed after 0°C)

PRINT key The key to store new water temperature, display **end** and return to the density mode. Proceed to Step 1.

CAL key The key to cancel the change and return to the density mode. Proceed to Step 1.

The relation between the water temperature and density

°C	+0	+1	+2	+3	+4	+5	+6	+7	+8	+9
0	0.99984	0.99990	0.99994	0.99996	0.99997	0.99996	0.99994	0.99990	0.99985	0.99978
10	0.99970	0.99961	0.99949	0.99938	0.99924	0.99910	0.99894	0.99877	0.99860	0.99841
20	0.99820	0.99799	0.99777	0.99754	0.99730	0.99704	0.99678	0.99651	0.99623	0.99594
30	0.99565	0.99534	0.99503	0.99470	0.99437	0.99403	0.99368	0.99333	0.99297	0.99259
40	0.99222	0.99183	0.99144	0.99104	0.99063	0.99021	0.98979	0.98936	0.98893	0.98849
50	0.98804	0.98758	0.98712	0.98665	0.98618	0.98570	0.98521	0.98471	0.98422	0.98371
60	0.98320	0.98268	0.98216	0.98163	0.98110	0.98055	0.98001	0.97946	0.97890	0.97834
70	0.97777	0.97720	0.97662	0.97603	0.97544	0.97485	0.97425	0.97364	0.97303	0.97242
80	0.97180	0.97117	0.97054	0.96991	0.96927	0.96862	0.96797	0.96731	0.96665	0.96600
90	0.96532	0.96465	0.96397	0.96328	0.96259	0.96190	0.96120	0.96050	0.95979	0.95906

Entering the density directly (I di n 1)

The density currently set (unit : g / cm³, factory setting : 1.0000g / cm³) is displayed.

Use the following keys to change the value.

The range to set the density is 0.0000g / cm³ to 1.9999g / cm³.



RE-ZERO(+)key... The key to set the value of the digit selected.

RANGE(-)key..... The key to select the digit to change the value.

PRINT key..... The key to store the change, display **end** and return to the density mode. Proceed to Step 1.

CAL key The key to cancel the change and return to the density mode. Proceed to Step 1.

Measuring the density

Note If the liquid temperature or the type of liquid is changed during measurement, input again the value of the liquid density as necessary.

Density display is four decimal places. Minimum display can not change with the **RANGE** key.

Density is displayed after "Mass measurement in air" and "Mass measurement in liquid".

The procedure of each measurements is as follows:

1 Enter the density mode that "g (gram)" is displayed and the processing indicator (◀) blinks. Put nothing on both pan and press the **RE-ZERO** key to display zero.

2 Put the sample on the pan in air.
If the weighing value is stored or outputted, press the **PRINT** key to store it after a stable weighing value is displayed.
Press the **RANGE** key to decide weighing value in air and proceed to next step.

Note If negative value or E (out of range) is displayed, the **RANGE** key is inactive.

3 Move the sample to the pan in liquid.
If the weighing value is stored or outputted, press the **PRINT** key to store it after a stable weighing value is displayed.
Press the **RANGE** key to decide weighing value in liquid and proceed to next step.

Note If E (out of range) is displayed, the **RANGE** key is inactive.

4 If the density value is stored or outputted, press the **PRINT** key to store it.
Press the **RANGE** key to measure other sample and proceed to step 2.

5 If the liquid temperature or the type of liquid is changed during measurement, input again the value of the liquid density as necessary.

6 Press the **MODE** key to proceed to other modes.

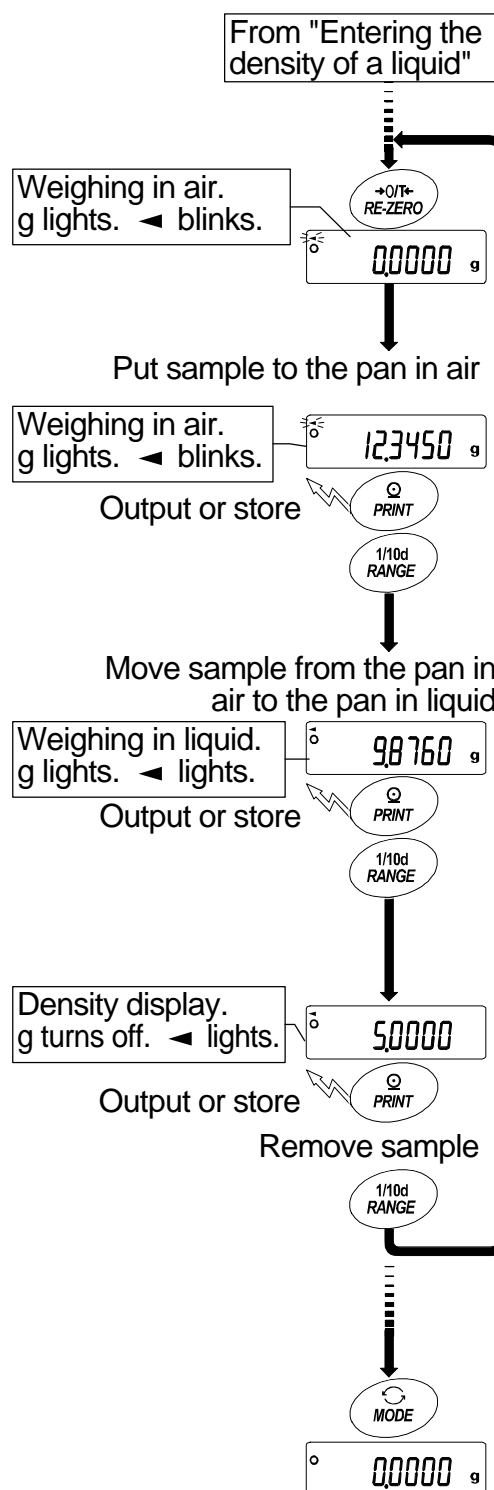

15. Standard Input & Output Interface

15.1. RS-232C Interface

The balance is a DCE device. Connect the balance to a personal computer (DTE) using a straight through cable.

- Transmission system : EIA RS-232C
- Transmission form : Asynchronous, bi-directional, half duplex
- Transmission rate : 10 times/second or 5 times/second (same as data refresh rate)
- Data format : Baud rate : 600, 1200, 2400, 4800, 9600, 19200bps
- Data bits : 7 or 8 bits
- Parity : Even, Odd (Data bits 7 bits)
- None (Data bits 8 bits)
- Stop bit : 1 bit
- Code : ASCII

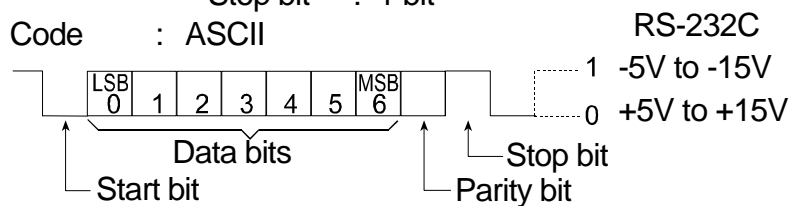

D-Sub 25 pin assignments

Pin No.	Signal name	Direction	Description
1	-	-	No connection
2	TXD	Output	Transmit data
3	RXD	Input	Receive data
4	-	-	No connection
5	SG	-	Signal ground
6	DSR	Output	Data set ready
7	RTS	Input	Request to send
8	CTS	Output	Clear to send
9	-	-	No connection

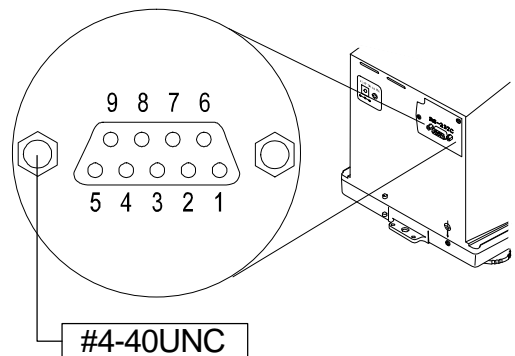

Signal names of the balance side are the same as the DTE side with TXD and RXD reversed.

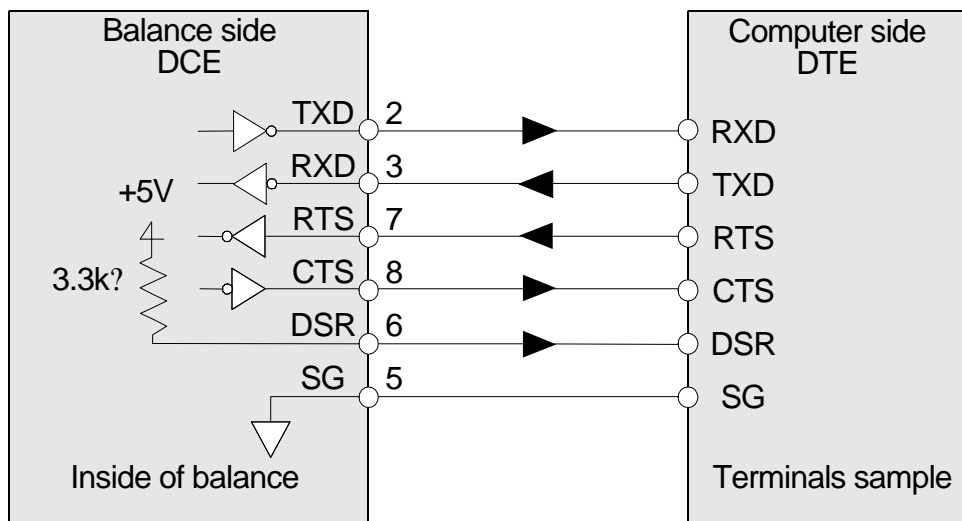

15.2. Connection to peripheral equipment

Connection To The AD-8121B Printer

Preset the following parameters to use the AD-8121B printer.

Function setting	Description
dout prt 0 to 3	Selects a print mode.
dout ap-p 0 to 2	Selects the polarity for the auto print mode.
dout ap-b 0 to 2	Selects the auto print difference.
dout pU5e 0,1	Selects data output pause.
5i f bp5 2 Factory setting	2400 bps
5i f btpr 0 Factory setting	7 bits, Even parity check
5i f Cr1 f 0 Factory setting	CR, LF
5i f Ct5 0 Factory setting	Inhibit the use of CTS and RTS control

When "MODE 1" or "MODE 2" of the AD-8121B printer is used

Function setting	Description
dout 5-td 0 Factory setting	Not to output the time and date.
dout 5-id 0 Factory setting	Not to output the ID number.
dout at-f 0 Factory setting	Not to use auto feed.
5i f type 0 Factory setting	A&D standard format

When "MODE 3" of the AD-8121B printer is used.

Function setting	Description
dout 5-td 0 to 3	Outputs the time and date as necessary.
dout 5-id 0,1	Outputs the ID number as necessary.
dout at-f 0,1	Uses auto feed as necessary.
5i f type 1	DP format

When data is transmitted continuously.

When all memory data is transmitted at one time.

Function setting	Description
dout pU5e 1	Uses pause.

Notes

The printer performs as follows, depending on the data memory setting.

Setting	Output data
data 0	The weighing data
data 1	The weighing data stored in memory
data 2	The calibration report stored in memory

Refer to "11.2. GLP Report" for print samples.

Connection To A Computer And The Use Of WinCT

The balance is of the DCE type (Data Communication Equipment), which can be connected to a personal computer using the RS-232C interface. Before connection, read the personal computer manual thoroughly. Use a standard DCE cable for connection (cable type: straight-through).

Using Windows Communication Tools Software (WinCT)

When Windows is used as an operating system in a personal computer, the provided WinCT software can be used to transmit the weighing data to the personal computer.

The WinCT software has two communication methods: "RsCom" and "RsKey". Refer to the WinCT instruction manual

RsCom

- RsCom can transmit commands to control the balance.
- RsCom can make bi-directional communication between the balance and a personal computer using the RS-232C interface.
- RsCom can display or store the data using a text file format. RsCom can also print the data using a printer connected to the personal computer.
- When several ports of a personal computer have balances connected, can communicate with each balance simultaneously.
- RsCom can share a personal computer with other application software.
- RsCom can receive the balance GLP report.

RsKey

- RsKey can transmit the weighing data output from the balance directly to other application software such as Microsoft Excel.
- RsKey can be used with most application software.
- RsKey can receive the balance GLP report.

Using the WinCT software, the balance can do the following:

- **Analyzing the weighing data and the statistics with "RsKey"**
The weighing data can be input directly into an Excel worksheet. Then, Excel can analyze the data to obtain total, average, standard deviation, maximum and minimum value, and display them in a graph.
- **Controlling the balance using commands from a personal computer**
By using "RsCom", the personal computer sends commands such as "re-zero" or "send weighing data" to the balance and controls the balance.
- **Printing the balance GLP report using your printer**
The balance GLP report can be printed using a printer connected to the personal computer.
- **Receiving weighing data at a certain interval**
The weighing data can be received at a certain interval and data characteristic with elapsed time can be obtained.
- **Using the balance memory function**
The data can be stored in the balance's memory. Of the data stored, the weighing data and calibration data can be transmitted to a personal computer at one time.
- **Using a personal computer as an external indicator**
With the "RsKey" test mode function, a personal computer can be used as an external weight indicator for the balance. (To do this, set the balance data output mode to stream mode.)

15.3. Commands

15.3.1. Command List

Note A command has a terminator added, that is specified using "5i f CrI f" of the function table, and is sent to the balance.

Commands to query weighing data	
C	Cancels the S or SIR command.
Q	Requests the weighing data immediately.
S	Requests the weighing data when stabilized.
SI	Requests the weighing data immediately.
SIR	Requests the weighing data continuously.

Commands to control the balance	
CAL	Same as the CAL key.
OFF	Turns the display off.
ON	Turns the display on.
P	Same as the ON:OFF key
PRT	Same as the PRINT key
R	Same as the RE-ZERO key
RNG	Same as the RANGE key.
TST	Perform calibration test.
U	Same as the MODE key

Commands to request data	
?ID	Requests the identification number.
?SN	Request the serial number of the balance.
?TN	Request the model name of the balance.

15.3.2. Acknowledge Code And Error Codes

When the "Serial interface function (5i f)" parameter is set to "erCd 1", the balance outputs <AK> code or error code to each command as follows:

<AK> (06h) Acknowledge in ASCII code.

- When the balance receives a command to request data and can not process it, the balance transmits an error code (EC, E_{xx}).

When the balance receives a command to request data and can process it, the balance outputs the data.

- When the balance receives a command to control the balance and can not process it, the balance transmits an error code (EC, E_{xx}).

When the balance receives a command to control the balance and can process it, the balance transmits the acknowledge code.

Among commands to control the balance, the following transmit the acknowledge code both when the balance receives the command and when the balance has accomplished the command. If the command can not be processed properly, the balance transmits an error code (EC, E_{xx}). This error can be released using the CAL command.

CAL command (Calibration command using internal mass)

ON command (Display ON command)

P command (Display ON/OFF command)

R command (RE-ZERO command)

TST command (Calibration test command)

- When a communication error has occurred due to external noise, or a parity error has occurred due to transmission error, the balance transmits an error code. In this case, send the command again.

xx is error code number.

15.3.3. Control Using CTS And RTS

Depending on the "Ct5" parameter of "Serial interface (5i f)", the balance performs as follows:

Ct5 0

Regardless of whether the balance can receive a command or not, the balance keeps the CTS line Hi. The balance outputs data regardless of the condition of the RTS line.

Ct5 1

The CTS line is kept Hi normally. When the balance can not receive the next command (Example: while the balance is processing the last command), the balance sets the CTS line to Lo. The balance confirms the level of the RTS line before outputting a set of data. If the RTS level is Hi, the balance outputs data. If the RTS level is Lo, data is not output (The data is canceled).

15.3.4. Settings Related To RS-232C

Concerning the RS-232C, the balance has two functions: "Data output (dout)" and "Serial interface (5i f)". Set each function as necessary.

15.3.5. Command Sample

This example is used the "erCd 1" of "5i f" so that <AK> (06h) code is outputted.

Example of ON command (turning on the balance)

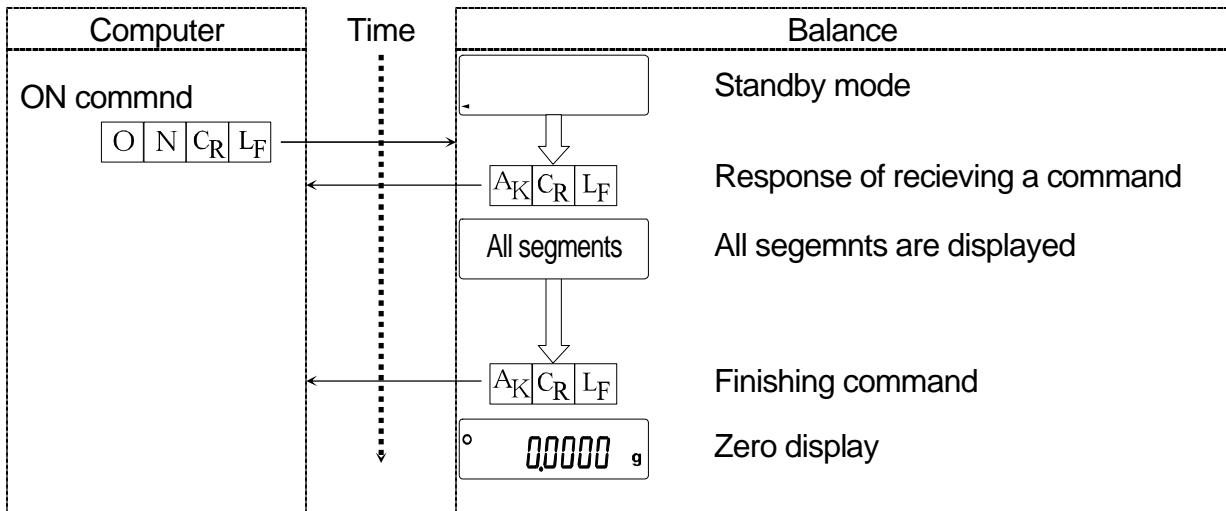

Example of R command (Re-zeroing the display)

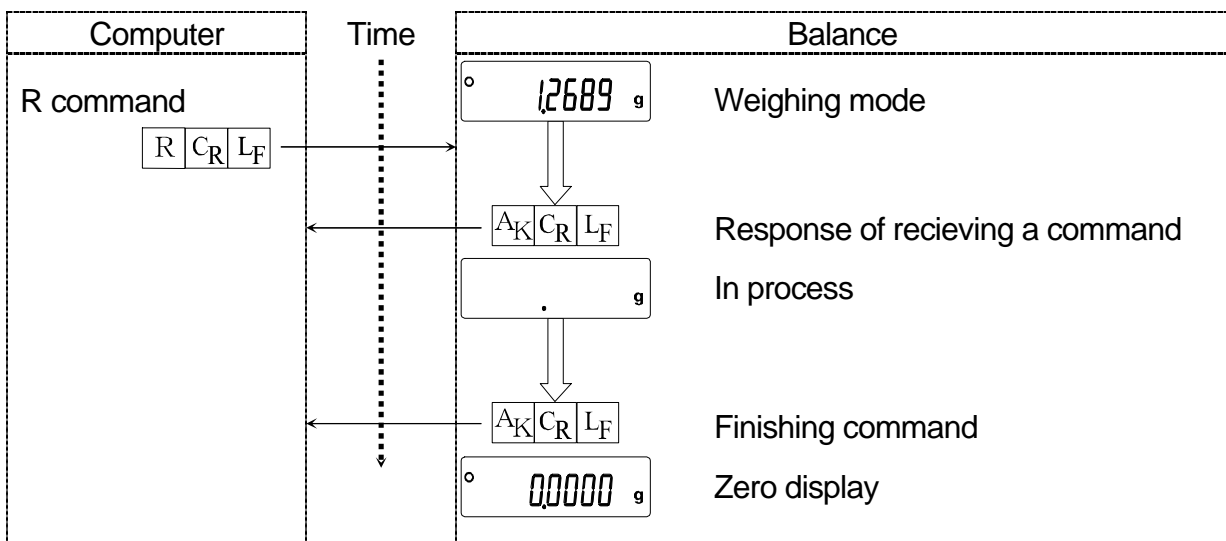

Example of CAL command (Calibration with internal mass)

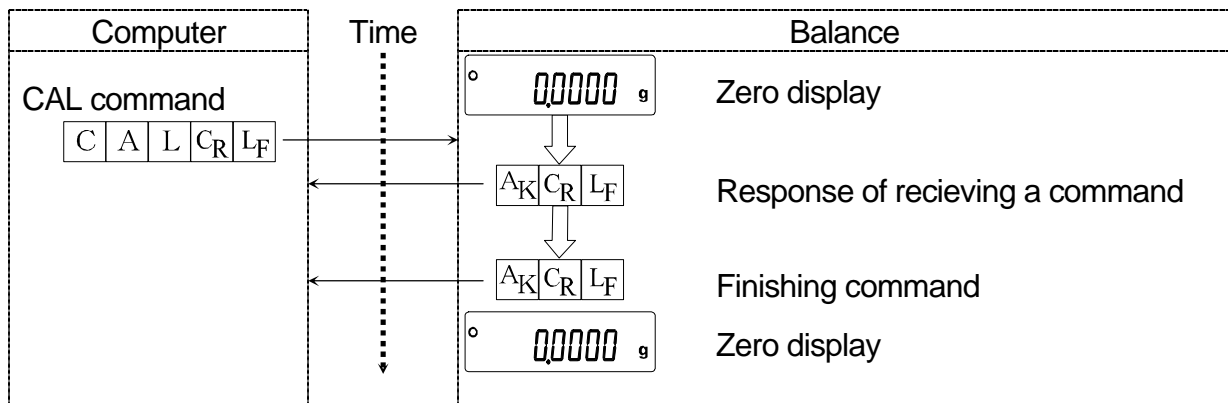

Example of Error code

This example is an error of R command. "erCd 1" is used. The balance transmits error code when received command can not be achieved.

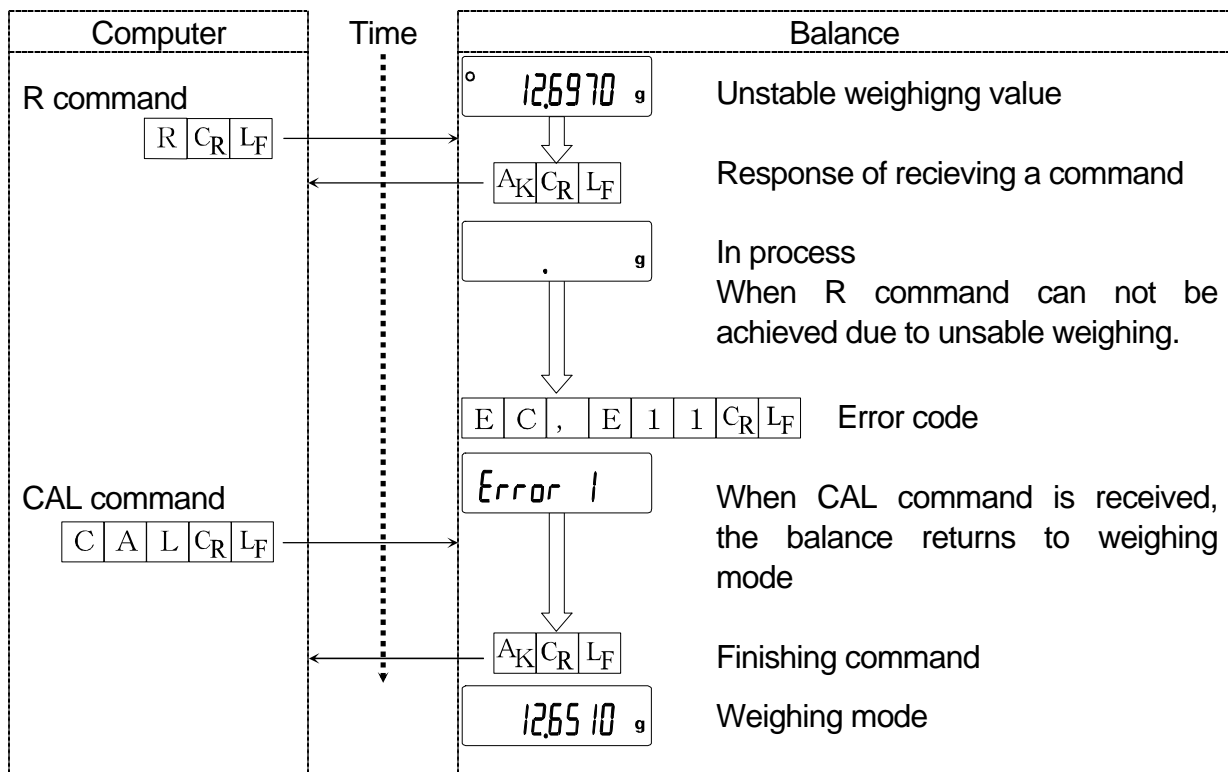









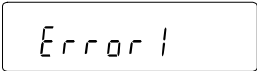

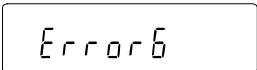
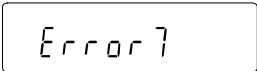
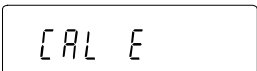
16. Maintenance

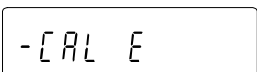
16.1. Treatment Of The Balance

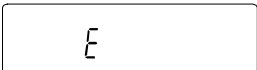
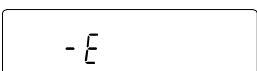
- Clean the balance with a lint free cloth that is moistened with warm water and a mild detergent.
- Do not use organic solvents to clean the balance.
- Do not disassemble the balance. Contact the local A&D dealer if the balance needs service or repair.
- Use the original packing material for transportation.
- Consider "3. Precautions" when operation the balance.

16.2. Error Codes

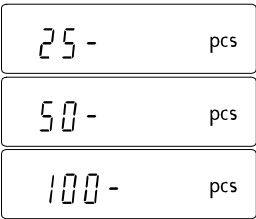
Display	Error code	Description
	EC,E11	Stability error The balance can not stabilize due to an environmental problem. Check around the pan. Prevent vibration, drafts, temperature changes, static electricity and magnetic fields, from influencing the balance. To return to the weighing mode, press the  key.
	EC,E16	Internal mass error Applying the internal mass does not yield a change in the mass value as specified. Confirm that there is nothing on the pan and perform the weighing operation from the beginning again.
	EC,E17	Internal mass error The internal mass application mechanism does not function properly. Perform the weighing operation from the beginning again.
	EC,E20	Calibration weight error The calibration weight is too heavy. Confirm the calibration mass value. Press the  key to return to the weighing mode.
	EC,E21	Calibration weight error The calibration weight is too light. Confirm the calibration mass value. Press the  key to return to the weighing mode.
		Overload error A sample beyond the balance weighing capacity has been placed on the pan. Remove the sample from the pan.
		Weighing pan Error The mass value is too light. Confirm that the weighing pan is properly installed and calibrate the balance.

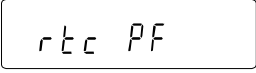
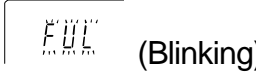
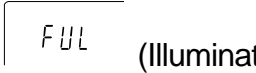
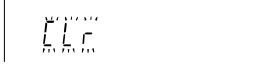
Display	Error code	Description
		Sample mass error The balance can not store the sample for the counting mode or for the percent mode because it is too light. Use a larger sample.
		Unit mass error The sample unit mass for the counting mode is too light. Storing and using it for counting will cause a counting error. Add samples to reach the specified number and press the PRINT key. Pressing the PRINT key without adding samples will shift the balance to the counting mode. But, to acquire accurate weighing, be sure to add samples.
		Automatic response adjustment zero error The automatic response adjustment can not be performed because there is something on the pan. Clear the pan. Press the CAL key to return to the weighing mode.
 (Check NG)		Automatic response adjustment unstable error The automatic response adjustment can not be performed because the mass value is unstable. Check the ambient conditions such as breeze, vibration and magnetic fields, also check the weighing pan. Press the CAL key to return to the weighing mode.
		Clock battery error The clock backup battery has been depleted. Press any key and set the time and date. The clock and calendar function works normally as long as the AC adapter is connected to the balance. If this error appears frequently, contact the local A&D dealer.
 (Blinking)		Memory full The amount of weighing data in memory has reached the maximum capacity. Delete data in memory to store new data. For details, refer to "12. Data Memory".
 (Illuminated)		Memory full The amount of calibration or calibration test data in memory has reached the maximum capacity (50 sets). The data in memory will be deleted automatically to store new data. For details, refer to "12. Data Memory".
		Memory type error Type of memory set in the function table and type of data stored are different. For details, refer to "12. Data Memory".
	EC,E00	Communications error A protocol error occurred in communications. Confirm the format, baud rate and parity.
	EC,E01	Undefined command error An undefined command was received. Confirm the command.

Display	Error code	Description
	EC,E02	<p>Not ready A received command can not be processed. Example:</p> <ul style="list-style-type: none"> □ The balance received a "Q" command, but not in the weighing mode. □ The balance received a "Q" command while processing a RE-ZERO command. Adjust the delay time to transmit a command.
	EC,E03	<p>Timeout error If the timeout parameter is set to "t-Up1", the balance did not receive the next character of a command within the time limit of one second. Confirm the communication.</p>
	EC,E04	<p>Excess characters error The balance received excessive characters in a command. Confirm the command.</p>
	EC,E06	<p>Format error A command includes incorrect data. Example:</p> <ul style="list-style-type: none"> □ The data is numerically incorrect. <p>Confirm the command.</p>
	EC,E07	<p>Parameter setting error The received data exceeds the range that the balance can accept. Confirm the parameter range of the command.</p>
Other error code		If an error described above can not be released or other errors are displayed, contact the local A&D dealer.

16.3. Other Display



When this indicator blinks, automatic self calibration is required. The indicator blinks when the balance detects changes in ambient temperature. If the balance is not used for several minutes with this indicator blinking, the balance performs automatic self calibration. The blinking period depends on the operating environment.

Advise The balance can be used while this indicator is blinking. We recommend that you perform automatic self calibration for precision weighing.

16.4. Checking The Balance Performance And Environment

The balance is a precision instrument. When the operating environment or the operating method is inadequate, correct weighing can not be performed. Place a sample on the pan and remove it, and repeat this several times. If the balance seems to have a problem with repeatability or to perform improperly, check as described below. If improper performance persists after checking, contact the local A&D dealer for repair.

Checking that the operating environment or weighing method is proper

Operating environment

- Is the weighing table solid enough?
- Is the balance level?
- Is the operating environment free from vibration and drafts?
- Is there a strong electrical or magnetic noise source such as a motor near the balance?

Weighing method

- Does the weighing pan touch the rim or anything? Is the weighing pan and pan support installed correctly?
- Is the **RE-ZERO** key pressed before placing a sample on the weighing pan?
- Is the sample placed in the center of the weighing pan?
- Is the fine range breeze break ring installed on weighing of which the minimum display is 0.01 mg for GH-252 and GH-202?
- Has the balance been calibrated using the internal mass (one-touch calibration)?
- Has the balance been warmed up for one hour before weighing?

Sample and container

- Has the sample absorbed or lost moisture due to the ambient conditions such as temperature and humidity?
- Has the temperature of the container been allowed to equalize to the ambient temperature?
- Is the sample charged with static electricity?
- Is the sample of magnetic material such as iron? There are cautions to weigh magnetic materials.

Checking that the balance performs properly

- Check the balance performance using an external weight. Be sure to place the weight in the center of the weighing pan.
- Check the balance repeatability, linearity and calibrated value using external weights with a known value.

16.5. Asking For Repair

If the balance needs service or repair, contact your local A&D dealer.

The balance is a precision instrument. Use much care when handling the balance and observe the following when transporting the balance.

- Use the original packing material for transportation.
- Remove the draft gate, weighing pan and pan support from the main unit.

17. Specifications

	GH-120	GH-200	GH-300	GH-202	GH-252
Weighing capacity	120 g	220 g	320 g	220 g	250 g
				51 g	101 g
Maximum display	120.0084 g	220.0084 g	320.0084 g	220.0084 g	250.0084 g
				51.00009 g	101.00009 g
Minimum display	0.1 mg			0.1 mg	
				0.01 mg	
Repeatability (Standard deviation)	0.1 mg		0.2mg	0.1 mg	
				0.02 mg	0.03 mg
Linearity	±0.2 mg		±0.3 mg	±0.2 mg	
				±0.03 mg	±0.10 mg
Stabilization time (Typical at <u>FAST</u>)	Approx. 3.5 seconds			Approx. 3.5 seconds	
				Approx. 8 seconds	
Sensitivity drift, 10°C to 30°C / 50°F to 86°F	±2 ppm/°C				
Operating environment	5°C to 40°C, 85%RH or less (No condensation)				
Display refresh rate	5 times/second or 10 times/second				
Counting mode	Minimum unit mass	0.1 mg			
	Number of samples	10, 25, 50 or 100 pieces			
Percent mode	Minimum 100% reference mass	10.0 mg			
	Minimum 100% display	0.01 %, 0.1 %, 1 % (Depends on the reference mass stored.)			
Interface	RS-232C with Windows Communication Tools Software WinCT				
External calibration weight	100g 50g	200g 100g	300g 200g 100g	200g 100g 50g 20g	
Weighing pan	∅90 mm				
External dimensions	217(W) x 442(D) x 316(H) mm				
Power supply & AC adapter type	Power consumption: Approx. 11VA (supplied to the AC adapter) Confirm that the adapter type is correct for the local voltage and power receptacle type.				
Mass	Approx. 8.2 kg				

- Operating environment does not include excessive change of ambient temperature and humidity, vibration, draft, magnetic fields and static electricity.
- The internal mass may change due to corrosion or other damage caused by the operating environment, or due to aging. Check the internal mass periodically and correct the internal mass value if necessary.

17.1. External Dimensions

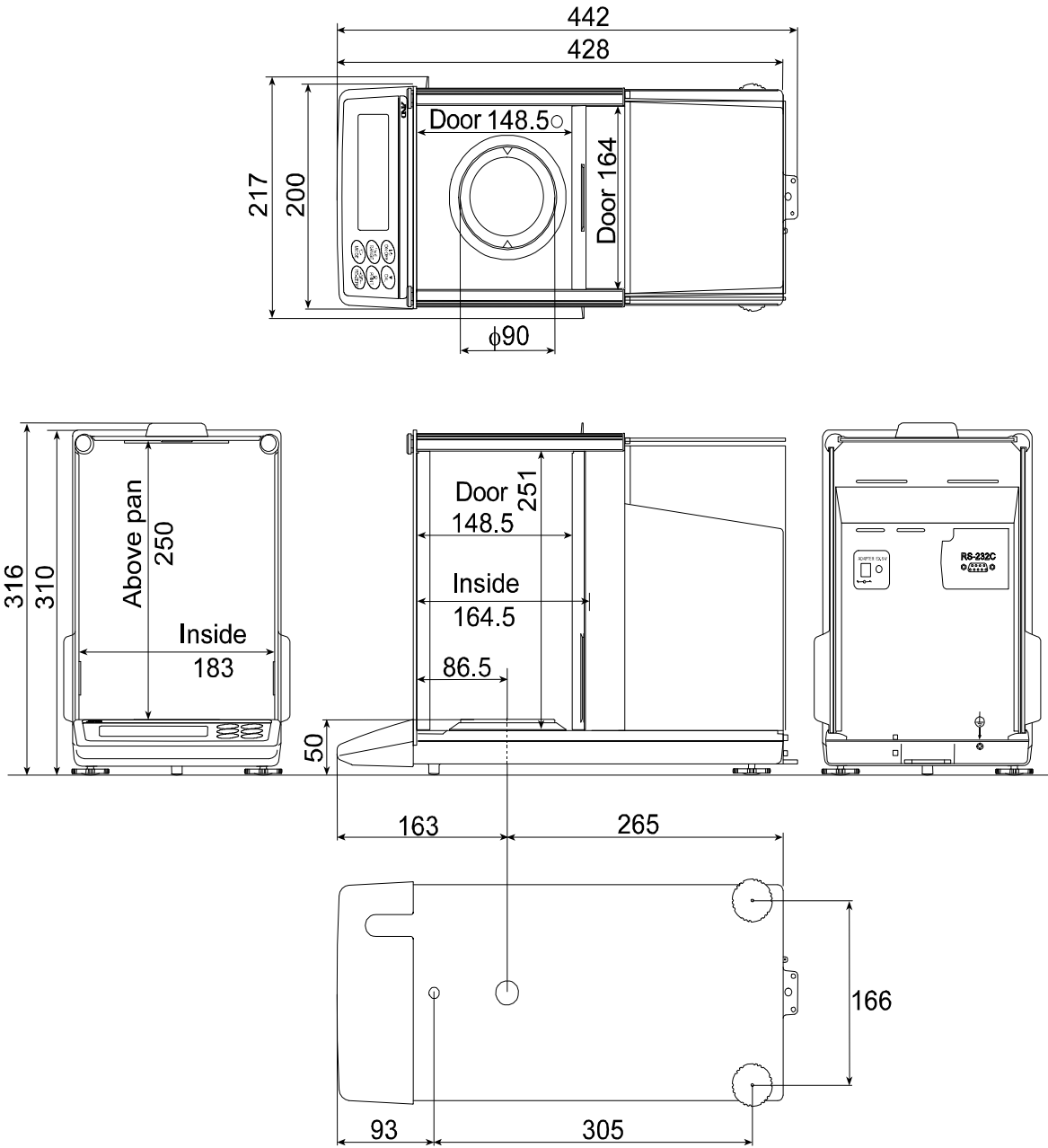

Unit: mm

17.2. Options and Peripheral Instruments

AD-8121B Printer

- Compact dot-matrix printer
- Statistical function, clock and calendar function, interval print function, graphic print function, dump print mode
- 5 x 7 dots, 16 characters per line
- Print paper (AX-PP143, 45 (W) x 50 (L) mm , ø65 mm)
- AC adapter or alkaline battery

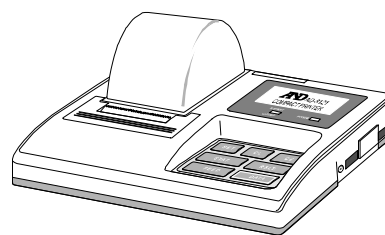

AD-1653 Density Determination Kit

$$\frac{\text{Weigh in air}}{\text{Weigh in water} - \text{Weigh in the air}} \times \text{water density} = \text{sample density}$$

Example

$$\frac{10.0000 \text{ g}}{10.0000 \text{ g} - 9.5334} \times 0.9970 \text{ g/cm}^3 = 21.4 \text{ g/cm}^3$$

Temperature	Water density
0°C	0.99984 g/cm ³
10°C	0.99970 g/cm ³
20°C	0.99820 g/cm ³
30°C	0.99565 g/cm ³

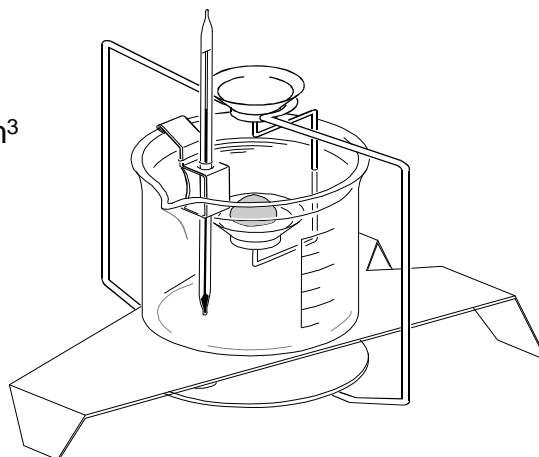

External key Plug AX-T-314A-S

This plug produces the same operations as pressing the **RE-ZERO** and **PRINT** keys. It enables remote control of the balance using an external key.

This operation must connect the GND line to the PRINT or RE-ZERO line for at least 100 milli-seconds.

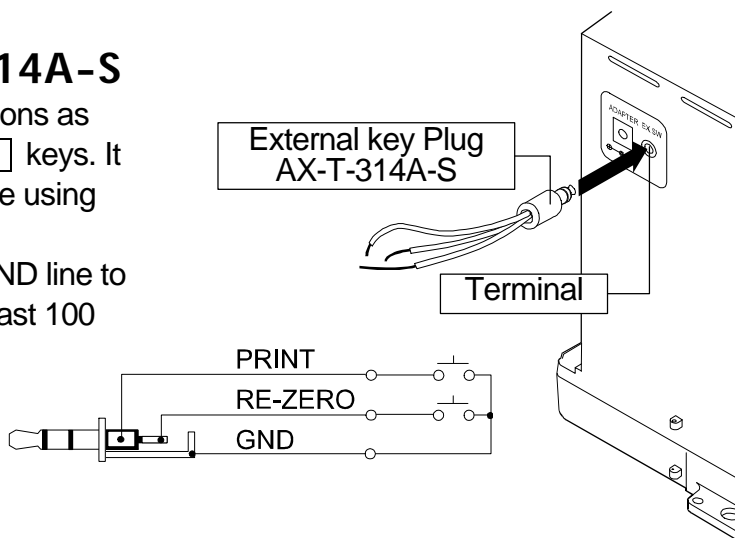

Foot switch AX-SW128

The switch can be used to connect the external key plug and used to the **RE-ZERO** and **PRINT** keys.

Note When using the foot switch, connect AX-SW128 and AX-T-314A-S by yourself.

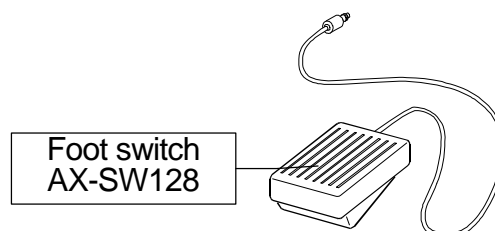

Other accessories















Order code	Name and description
AD-1682	Rechargeable Battery <ul style="list-style-type: none"><li data-bbox="470 365 1441 443">□ This option allows use of the balance in a place where AC power is not available.
AD-1683	Static Eliminator <ul style="list-style-type: none"><li data-bbox="470 488 1441 566">□ This option can be used to eliminate the static electricity of weighing samples.
AD-8524A/B	Keyboard Adapter <ul style="list-style-type: none"><li data-bbox="470 611 1441 689">□ This option can be used to connect the balance to a personal computer with appropriate OS and applications.
AD-8920	Remote Display <ul style="list-style-type: none"><li data-bbox="470 734 1441 799">□ This option can be connected to the balance using the RS-232C interface.

18. Terms/Index

18.1. Terms

Calibration	Adjustment of the balance so that it can weigh accurately.
Calibration weight	A weight used for calibration
Data number	Numbers assigned sequentially when weighing data or unit weight is stored.
Digit	The minimum weighing value available. Used for the balance, one digit is the smallest mass that can be displayed.
Environment	Ambient conditions such as vibration, drafts, temperature, static electricity and magnetic fields which affect the weighing operation.
External weight	The weight that you have.
GLP	Good Laboratory Practice.
GMP	Good Manufacturing Practice
Internal mass	Built-in calibration weight
ISO	International Organization for Standardization
Repeatability	Variation in measured values obtained when the same mass is placed and removed repetitively. Usually expressed as a standard deviation. Example: Standard deviation = 1 digit: This means that measured values, obtained when the same sample is placed and removed repetitively, fall within ± 1 digit in the frequency of about 68%.
Re-zero	To set the display to zero.
Sensitivity drift	An affect that a change in temperature causes to the weighing data. Expressed as a temperature coefficient. Example: Temperature coefficient = 2 ppm/ $^{\circ}$ C : If a load is 10 g and the temperature changes by 10 $^{\circ}$ C, the value displayed changes by the following value. $0.0002\%/^{\circ}$ C x 10 $^{\circ}$ C x 10g = 0.0002 g
Stabilization time	Time required after a sample being placed, until the stabilization indicator illuminates and the weighing data is displayed.
Tare	To cancel the mass value of a container which is not to be included in the weighing data. Normally, refers to an operation of placing a container and setting the display to zero.
Target mass	An external weight used for calibration test
Zero point	A weighing reference point. Usually refers to the value displayed when nothing is on the weighing pan.

18.2. Index

- % Unit of percent mode 16
-  CAL key 9, 30
-  MODE key 9
-  ON/OFF key 9
-  PRINT key 9, 30
-  RANGE key 9, 30
-  RE-ZERO key 9, 30
-  Data number 9, 35, 47
-  Interval memory mode 9, 47
-  Prior notice indicator 9, 20
-  Process indicator 9
-  Space mark 36, 41, 42, 43, 44, 45
-  Stabilization indicator 9, 12, 30
-  Standby indicator 9
-  RESPONSE **FAST** **MID** **SLOW** Response indicator 9
- A&D format 33
- AC adapter 5, 66
- ACAI Function 15
- Accessory 68
- AD-1682 68
- AD-8121B Printer 56, 67
- AD-8524 68
- AD-8920 68
- AK code 59
- ap-b Auto print difference 28, 32
- ar-d Zero after output 29
- ap-p Auto print polarity 28, 32
- at-f Auto feed 29
- ba5fnc Environment display 27, 28
- bp5 Baud rate 29
- btpr Data bit, parity bit 29
- C5 i n Internal mass correction 24
- Cal e Calibration weight error 62
- Cal e Calibration weight error 62
- Cal i n One-touch calibration 20
- Cal out Calibration using an external weight... 22
- Calibration 19, 23, 69
- Calibration test 19
- CC i n Calibration test 21
- CC out Calibration test 23
- CH 0 Response error 63
- Cl adj Clock 28
- Cl r Initializing the balance 26
- Cond Condition 17, 28, 31
- CrI f Terminator 29
- C5 i n Internal mass correction 30
- CSV format 35
- Ct5 CTS, RTS control 30
- CTS 59
- d- Weighing data with calender 46
- data Data memory 28
- Data number 69
- Digit 69
- d-no Data number output 29
- dout Data output 28, 29, 32
- d5 fnc Density function 30
- d-t Weighing data 46
- Dump print 33
- e Weighing pan Error 62
- e Overload error 62
- EC,E00 Communications error 63
- EC,E01 Undefined command error 63
- EC,E02 Not ready 64
- EC,E03 Timeout error 64
- EC,E04 Excess characters error 64
- EC,E06 Format error 64
- EC,E07 Parameter setting error 64
- EC,E11 Stability error 62
- EC,E16 Internal mass error 62
- EC,E17 Internal mass error 62
- EC,E20 Internal mass error 62
- EC,E21 Internal mass error 62
- erCd AK, Error code 30
- error 1 Stability error 62
- error 6 Internal mass error 62
- error 7 Internal mass error 62
- Error code 62
- External weight 19, 69
- FAST 17
- FCC 4
- fUI Memory full 47, 50, 63
- GLP 69
- GMP 69
- Hi 5 Calibration report 46
- i d ID number setting 30
- ID Number 35, 40
- i nfo GLP output 29
- i nt Interval time 29
- KF format 34
- l di n Liquid density input 30
- l o Sample mass error 63
- MID. 17
- MT format 34
- Numerical format 34
- out Report output 49, 50
- p5 internal mass correction 26
- pnt Decimal point 28, 31
- p-on Auto display-ON 28, 31
- prt Data output mode 28, 32
- pU5e Data output pause 29
- recend End bolck 45
- Repeatability 66, 69
- Re-zero 69

RsCom	57	5-td	Time/Date output.....	29
RsKey	57	Tare	12, 69
rtc	Clock battery error	63	Target mass	69
RTS	59	trc	Zero tracking	28, 31
5-i d	ID number output	29	t-Up	Timeout.....	30
5i f	Serial interface	29	type	Data format.....	29
SLOW	17	PCS	Unit of counting mode.....	14
5pd	Display refresh rate.....	28, 31	Unit	9, 10, 37
Stabilization time.....		66, 69	Uni t	Unit	30
5start	Title block	45	WinCT	Communication Tools	57
5t-b	Stability band width	28, 31	Zero point	69